



GYS

CAR BODY WELDING SYSTEMS 2023 B

www.gys.fr



INVEST IN THE FUTURE



French manufacturer
since 1964

Car Body Welding Systems

Catalogue Carrosserie

Catalogo Carrozzeria

Karosserie-Schweißtechnik Katalog

Catálogo de Soldadura para Carrocería

2
0
2
3
B



SPOT WELDING

DENT PULLER

MIG

PLASMA

INDUCTION

LIFT

RIVETING

BODYSHOP TOOLS

INVEST IN THE FUTURE

A solid manufacturing group

900 people € 125 000 000

C1+ Credit Rating Banque de France
55 000 m² 2 factories



INVEST IN THE FUTURE



French manufacturer since 1964

A family company



Nicolas & Bruno Bouygues

3 catalogues

3 500+ references



Welding, Plasma cutting & Induction heating



Car Body Welding Systems



Chargers, Boosters & Starters

A worldwide coverage

125 countries



GYS FRANCE
Laval

GYS GERMANY
Aachen

GYS U.K.
Rugby

GYS CHINA
Shanghai

GYS ITALIA
Venezia

GYS IBERICA
Madrid

www.gys.fr



visit with



DENT PULLING

GYSLOT	6
GYSLOT PRO	7
GYSLOT ALU	8
GYSLOT COMBI	9
ACCESSORIES & CONSUMABLES	10
GYSLOT ARCPULL	12
COMBI ARCPULL	13
ACCESSORIES & CONSUMABLES	16
FAST EASY TOOLS	18
ACCESSORIES LEVELLING BARS	20
COMPLETE WORKSTATIONS	24

PULLING SYSTEMS

AIRFIX DRAW ALIGNER	39
DRAW ALIGNER	40
FRAME STRAIGHTENING	42

PAINTLESS DENT REPAIR

POWERDUCTION AUTO DENT REPAIR	46
GLUE PULLING KITS	48

TRUCK TOOLS & MOBILE LIFTS

TROLLEY IW1 / MULTITOOL TRUCK	51
SPOT LIFT	52
ERGOLIFT / QUICKLIFT	54
AIR JACKS / MANUAL WHEEL LIFT	55

SPOT WELDING

TECHNOLOGY	58
PORTASPOT / GYSLOT 32D-X / 100R-CX	61
GYSLOT BP-LX / BP-LC-S7	62
GYSLOT PTI-S7	63
GYSLOT BP GENIUS	66
GYSLOT PTI PREMIUM PRO	68
GYSLOT PTI GENIUS	70
G ARMS	72
ACCESSORIES & CONSUMABLES	73

RIVETING

GYSPRESS 10T	77
GYSPRESS 10T PP	78
GYSPRESS PREMIUM 10T PP	79
WORKSTATION	81
ADAPTERS	83
DIES BOXES & RIVETS	84
ACCESSORIES	87

MIG WELDING

GYS AUTO	90
MULTIPEARL AUTO	91
E GYS AUTO	92
AUTOPULSE	95
TORCHES & CONSUMABLES	98

INDUCTION HEATING

GYSDUCTION	102
COMBIDUCTION	103
POWERDUCTION	104
ACCESSORIES & CONSUMABLES	108

PLASMA

EASYCUT	112
CUTTER	113

ACCESSORIES

WELDING HELMETS	117
FUME EXTRACTION	121
WINDSCREEN REPAIR	122
BUMPER REPAIR	124
HAND TOOLS	126
PNEUMATIC TOOLS	128
SANDING & DUST EXTRACTION	130
WORKING LIGHTS	132
WORKING SUPPORTS	134
SAFETY PROTECTION	137



DENT PULLING

STEEL / ACIER / STAHL

GYSPOT	6
--------	---

GYSPOT PRO	7
------------	---

ALU

GYSPOT ALU	8
------------	---

ALU + STEEL / ACIER / STAHL

GYSPOT COMBI	9
--------------	---

ACCESSORIES & CONSUMABLES	10
---------------------------	----

DRAWN ARC

ALU + STEEL / ACIER / STAHL

GYSPOT ARCPULL	12
----------------	----

COMBI ARCPULL	13
---------------	----

ACCESSORIES & CONSUMABLES	16
---------------------------	----

FAST DENT PULLING	18
-------------------	----

LEVELLING BARS	20
----------------	----

COMPLETE WORKSTATIONS	24
-----------------------	----



GYSPOT

DENT PULLING STEEL ACIER - STAHL

- Stars - Étoiles - Ausbeulstern
- Rings - Anneaux - Zugösen
- Wavy wires - Fils ondulés - Wellendraht
- Impact shrinking - Rabattage d'impact - Glätten

OPTIONS

Consommables - Consumables p.10



Chariots - Trolleys p.24



- Stars - Étoiles - Ausbeulstern
- Rings - Anneaux - Zugösen
- Wavy wires - Fils ondulés - Wellendraht
- Impact shrinking - Rabattage d'impact - Glätten
- Tempering - Rétreinte - Temperieren



NEW DESIGN



FIXED GUN

FIXED GUN

GYSPOT 2600

2600 A x1 AUTOMATIC

230V • 1~

052208

included

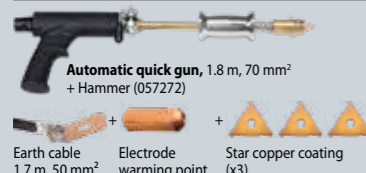

Earth cable 1.7 m, 50 mm² Electrode warming point Star copper coating (x3)

GYSPOT 2700

2600 A x1 MANUAL

230V • 1~

055353

included

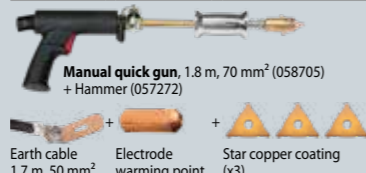

Earth cable 1.7 m, 50 mm² Electrode warming point Star copper coating (x3)

GYSPOT 34.02 & 34.04

3500 A x1 MANUAL

230V • 1~

GYSPOT 34.02 065741

400V • 2~

GYSPOT 34.04 067943

included

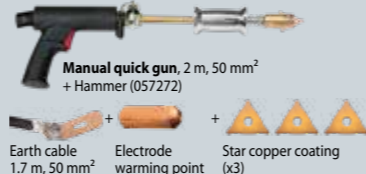

Earth cable 1.7 m, 50 mm² Electrode warming point Star copper coating (x3)

- Stars - Étoiles - Ausbeulstern
- Rings - Anneaux - Zugösen
- Wavy wires - Fils ondulés - Wellendraht
- Impact shrinking - Rabattage d'impact - Glätten
- Tempering - Rétreinte - Temperieren
- Rivets - Rivets - Nieten
- Rings - Rondelles - Unterlegscheiben
- Studs - Goujons - Gewindebolzen

SYNERGIC CONTROL

PATENTS REGISTERED NUMBERS EUROPEAN TRADEMARK & DESIGN



GUN WITH CONNECTOR

GYSPOT 39.02 & 39.04

3800 A x1 AUTOMATIC

230V • 1~

GYSPOT 39.02 052215

400V • 2~

GYSPOT 39.04 052222

included



Earth cable 2 m, 70 mm² SPOTTER BOX STANDARD (053915) (Details p.10)

GYSPOT PRO 230 & PRO 400

3800 A x2 AUTOMATIC MANUAL

230V • 1~

GYSPOT PRO 230 052178

400V • 2~

GYSPOT PRO 400 052185

included



Earth cable 2 m, 70 mm² SPOTTER BOX PRO (050075) (Details p.10)

GYSPOT EXPERT 200, 230 & 400

3800-4500 A x2 AUTOMATIC MANUAL

230V • 1~

GYSPOT EXPERT 230 066885

200-240V • 1~

GYSPOT EXPERT 200 058842

4350 • 5100 A

400V • 2~

GYSPOT EXPERT 400 058859

included



Earth cable Thick 3 mm 2 m, 70 mm² SPOTTER BOX PRO (050075) (Details p.10)

QUICK GUNS

Quick & Easy

AUTOMATIC



WITH CONNECTOR 2 m, Ø 70 mm² included 39.02/04 057517



WITH CONNECTOR 3 m, Ø 50 mm² included PRO 230/400 057500

WITH CONNECTOR 3 m, Ø 70 mm² included EXPERT 200/230/400 059207

MANUAL



WITH CONNECTOR cable 2 m, Ø 70 mm² included PRO 230/400, EXPERT 200/230/400, COMBI 230EPRO 057524

No connector cable 1.8 m, Ø 70 mm² for 2700 058705

No connector cable 2 m, Ø 50 mm² for 34.02/34.04

Mandrels for gun - Mandrins pour pistolets - Pistole & Anschlußstücke, Zubehör



QUICK GUN 057531



D1 048959



Nut - Écrou 053199

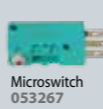

Microswitch 053267

MADE IN GYS CHINA	G NORM 62135	50/60 Hz	I ₂ max	U ₂	I _{AM}	I _{RMS}	kW	OK	OK	SYNERGIC	AUTOMATIC	MANUAL	SEPARATE CABLE GUN	LxWxH cm / kg
MADE IN GYS CHINA	GYSPOT 2600	230V	2 m	2600	5,4	16	1800	10	OK	—	—	—	—	40 x 25 x 31 / 18
	GYSPOT 2700	230V	2 m	2600	5,4	16	1800	10	OK	—	—	—	—	40 x 25 x 31 / 18
	GYSPOT 34.02	230V	2 m	3500	7,4	16	2500	20	OK	OK	—	—	—	42 x 36 x 31 / 23.9
	GYSPOT 34.04	400V, 2ph	4 m	3500	7,4	16	2500	20	OK	OK	—	—	—	42 x 36 x 31 / 24
MADE IN FRANCE	GYSPOT 39.02	230V	4 m	3800	7,4	16	2800	20	OK	OK	—	—	—	49 x 38 x 29 / 27.5
	GYSPOT 39.04	400V, 2ph	4 m	3800	7,4	16	2800	20	OK	OK	—	—	—	49 x 38 x 29 / 25.2
	GYSPOT PRO 230	230V	8 m	3800	7,4	16	2800	20	OK	OK	—	—	—	49 x 38 x 29 / 29.6
	GYSPOT PRO 400	400V, 2ph	8 m	3800	7,4	16	2800	20	OK	OK	—	—	—	49 x 38 x 29 / 29.4
	GYSPOT EXPERT 200	200-240V	8 m	4350 • 5100	7,2-8,7	30(D)	3100 • 3600	25 • 36	OK	OK	—	—	—	49 x 38 x 29 / 34.6
	GYSPOT EXPERT 230	230V	8 m	3800	7,4	16	2800	20	OK	OK	—	—	—	49 x 37 x 31 / 30.6
	GYSPOT EXPERT 400	400V, 2ph	8 m	4500	7,4	16(D)	3200	25	OK	OK	—	—	—	49 x 38 x 29 / 32.9



GYSPOT ALU

DENT PULLING ALU

FV FLEXIBLE VOLTAGE

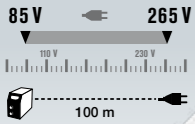

FIXED GUN

SYNERGIC CONTROL PATENTS REGISTERED NUMBERS EUROPEAN TRADEMARK & DESIGN

Alu

Goujons - Studs

Steel / Acier / Stahl

- Stars - Étoiles
- Rings - Anneaux
- Wavy wires - Fils ondulés
- Impact shrinking - Rabattage d'impact
- Tempering - Rétreinte
- Rivets - Rivets
- Rings - Rondelles
- Studs - Goujons

GYSPOT ALU PRO FV

100 · 230V · 1~
7500 A x1 **AUTOMATIC**

FV

021990

included for Ø 4 mm



Automatic alu gun
3 m, 25 mm²



ALU BOX STANDARD (050020)
(Details p.11)

ALU GUN

AUTOMATIC

3 m, Ø 25 mm²

included SPOT ALU FV & COMBISLOT 230

(x 3)
065635

66 mF CAPACITOR DISCHARGE WELDING

Ø 4mm

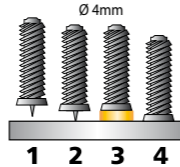

Joint rings for mandrel Ø 4/5/6 x 2
060814

PATENTS REGISTERED NUMBERS 002446450-0001 EUROPEAN TRADEMARK & DESIGN

OPTIONS

Consumables - Consommables p.11



ALU accessories - Accessoires ALU p.19



Trolleys - Chariots p.24



GYSPOT COMBI

DENT PULLING ALU + STEEL ACIER - STAHL

2 GUNS INCLUDED



GUN WITH CONNECTOR

GYSPOT COMBI 230 E.PRO

230V · 1~
3800 A Acier / Steel / Stahl
7500 A Alu

x2 **AUTOMATIC**
MANUAL
AUTOMATIC

021266

included



Manual quick gun, 2 m, 70 mm² (057524)
+ Hammer (057272)

Automatic alu gun, 3 m, 25 mm²



Earth cable
2 m, 70 mm²

SPOTTER BOX PRO (050075)
(Details p.10)

ALU BOX STANDARD (050020)
(Details p.11)

MADE IN FRANCE 62135	50/60 Hz			I ₂ max A	U ₂ V		I _{RMS} A	kW			MANUAL	SYNERGIC			AUTOMATIC	MANUAL	SEPARATE CABLE GUN			LxWxH cm / kg
GYSPOT ALU PRO FV	110 · 230V	6 m	7500	50 · 200	5	—	0.65	OK	OK	■	■	—	■	x1	—	—	3 m	Included Alu box	49 x 38 x 29 / 13.4	
GYSPOT COMBI 230 E.PRO	230V	8 m	3800 (steel) 7500 (alu)	7,4 (steel) 50 · 200 (alu)	16	2800 (steel)	20	OK	OK	—	■	■	■	x1	x1	■	2/3 m	Included Spotter box + Alu box	54 x 76 x 34 / 47.5	

GYSPOT

ALU + STEEL DENT PULLING



STEEL / ACIER / STAHL



DENT BOX
CONSUMABLES / BAR / EASY



SPOTTER BOX
STANDARD / 2600 / 2700



SPOTTER BOX PRO

Star - Étoile - Ausbeulstern	Ring - Rondelle - Unterlegscheiben	Tempering - Rétreinte - Temperieren	Impact shrinking & Lock nut - Rabattage d'impact & Écrou - Glätten	Wavy wire - Fil ondulé - Wellendraht
hexagon	chuck for inertia hammer	carbon heating electrode	electrode for spot welding machine only	electrode
Earth plate small	copper coating star	electrode	Ball electrode	wavy wire
x1	ø 8 x 16	earth hook	M8	magnetic positioner
x20	electrode ø 16 for 8 x 16	x5	x1	x50
049482	052239	049468	049567	049789
	049574	049444	059726	049727
	056718	050303	050303	049772

Rings - Anneaux - Zugösen	Studs - Goujons - Gewindebolzen	Rivets - Rivets - Nieten	Nails - Clous	Stitch welding - Molette	Rubber pad 062399
elec-trode	electrode for threaded studs	electrode ø 16,3 x 4,50	electrode ø2 - M4	electrode wheel ø16	flat n°27
straight rings	threaded M5 x 18 x 0.8	ø 3 x 3.25	ø2	for spot welding machine only	Earth plate large
twisted rings	self-threading ø 5 x 18	ø 3 x 4.50	x100	x1	magnetic
lifting rod	ø 5 x 12	x1	x1	x1	Steel gun earth adapter Ø 25 mm
x1	x100	x100	x100	x1	x1
x100	x100	x100	x100	x100	x1
050655	049598	049604	049277	050310	049673
050648	049383	049345	041561	052529	052529
050631	049420	049352		049666	051997
	049413				

DENT BOX

CONSUMABLES

051515	x20
050037	x1 x25
053632	x1 x25

SPOTTER BOX

050075	x1	x1	x1	x20	x1	x50	x1	x1	x1
053915	x1	x1	x1	x20	x1	x50	x1	x1	x1
052277			x20	x1	x50	x1			
053922			x20	x1	x50	x1			x1

ELECTRODE FOR MAGNETIC EARTH (x1) 050013

THREADED ROD FOR MAGNETIC EARTH (x5) 055438

SINGLE HOOK (x1) 051218

Curved lifting rod 280 mm 064706

Steel Ring sharpener - Affuteur d'anneaux acier - Stahl Zugöschneider 072565

072299 Pneumatic punch and die sharpener for steel rings Poinçon et matrice affuteur pneumatique pour anneaux acier

SLIDE HAMMERS - Marteaux inertie - Ausbeulhammer

COMPLETE 057272

1.1 kg

Options: (x1) 054028, (x5) 050839

included (x1) 049482, included (x20) 052239

COMPLETE KIT 051225

2.5 kg

(x50), (x1), (x25), (x1), (x1)

Pulling handle 3 claws - Poignée de tirage 3 dents - Handzugkralle 3-fach 057326

Pulling handle 2 claws - Poignée de tirage 2 dents - Handzugkralle 2-fach 057319

Nails - Clous - Nägel 041813

1.1 kg

Ø 2, M4 (x1) 049277, Ø 2 (x100) 041561

MIG/MAG nozzle for Nail welding 041523

Washers - Rondelles - Ringe 051201

1.7 kg

51 cm

Ø 16, 8x16 (x1) 049574, 8x16 (x100) 049444, (x1) 051218

Slide hammer kit - Kit marteau à inertie - Ausbeulhammerset 051928

6 kg

ALU

ALU BOX LIGHT Ø4 / STANDARD Ø4 / Ø5 & 6

Joint rings for mandrel Ø 4/5/6 x2 060814

mandrel for ALU GUN	alu magnesium screws 12 mm	alu silicon screws 12 mm	screwable rings	fast pulling rings	lifting rod
ø 4 x2	ø 4 - M4 x200	ø 4 - M4 x1000	ø 4 x5	x5	x3: 180, 300, 500 mm
ø 5 x1	ø 5 x100	ø 5 x100	ø 5 x100		050792
ø 6 x1	ø 6 x100	ø 6 x100	ø 6 x100		
049000	050273	050280	050297	058712	
048157	050129	050136			
048164	048140	048133			
	048140	048133			
	048140	048133			

ALU BOX

LIGHT Ø 4 051522	x200	x200			
STANDARD Ø 4 050020	x200	x200	x5		
Ø 5 & 6 048195	x1	x1		x5	x1



DENT PULLING DRAWN ARC ALU + STEEL

ACIER - STAHL



MANUAL

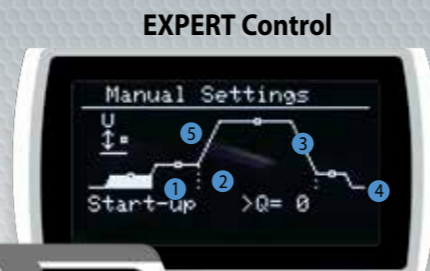

- 1 Start-up - Amorce - Zündung
- 2 Scouring (I & t) - Décapage - Abbeizen
- 3 Arc (I & t) - Arc - Lichtbogen
- 4 Hitching (I & t) - Accroche - Verklebung
- 5 Height - Hauteur - Höhe

- Rings - Anneaux - Zugösen
- Studs - Goujons - Gewindebolzen
- Stainless steel nails - Tiges inox - Edelstahlnägel



7 languages
FR, EN, DE, SP, IT, NL & RU

SYNERGIC DIGITAL GUNS

★★★★★
UNIQUE Linear Motor

DRAWN ARC PROCESS
Gas protection

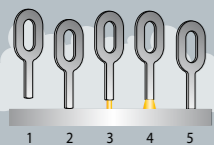

3 m, Ø 25 mm²
included ARCPULL 200 & 350, COMBI ARCPULL



Full control



Consumables for Gun



FV FLEXIBLE VOLTAGE

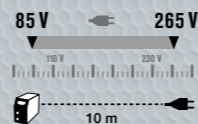

SR SECONDARY REGULATION

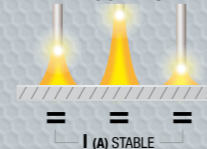

AD ANTI-DUST

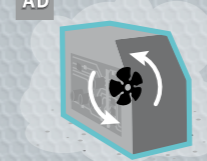

MANUAL & SYNERGIC CONTROL

NEW

2 GUNS INCLUDED



Ø max
Alu : 6 mm
Fe : 6 mm



GUN WITH CONNECTOR

GYSPOT ARCPULL 200

100 · 230V · 1~
200 A **1x1 MANUAL**
FV SR AD
057470
included

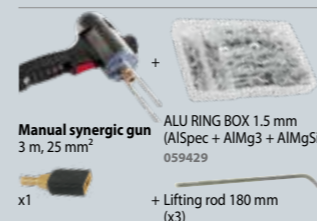

ALU RING BOX 1.5 mm (AlSpec + AlMg3 + AlMgSi) 059429
+ Lifting rod 180 mm (x3)

OPTIONS

Weld 810 for ARCPULL 200 037489

COMBI ARCPULL

230V · 1~
ARCPULL 200 A + **EXPERT 3800 A**
Alu + Acier / Steel / Stahl
1x1 MANUAL + **1x1 MANUAL**

069824

Arcpull accessories included



ALU RING BOX 1.5 mm (AlSpec + AlMg3 + AlMgSi) 059429
+ Lifting rod 180 mm (x3)

Expert accessories included



Manual quick gun, 2 m, 70 mm² (057524) + Hammer (057272)

Earth cable, 2 m, 70 mm² SPOTTER BOX PRO (050075) (Details p.10)

MADE IN FRANCE 60974-1	50/60 Hz	I ₂ A	SYNERGIC	MANUAL	IRMS (A)	GUN		U ₂ V	A	kW	OK	OK	LxWxH cm / kg
						Acier/Steel	Alu						
GYSPOT ARCPULL 200	110 · 230V	6 m	10 · 100 (110 V) 10 · 200 (230 V)	■	■	—	Manual + Digital Gun Motion Control	20.4 · 24 V (110 V) 20.4 · 28 V (230 V)	16	2.4 (110 V) 5.6 (230 V)	OK	OK	49 x 37 x 30 / 14.5
COMBI ARCPULL	230V	8 m	Alu 10 · 200 Acier 3800	■	■	Steel 3800	Manual Automatic (not included)	Alu 20.4 · 28 V Steel 7.4 V	16	Alu 5.6 Steel 20	OK	OK	72 x 42 x 29 / 41.5



GYS POT ARCPULL

DENT PULLING DRAWN ARC ALU + STEEL ACIER - STAHL

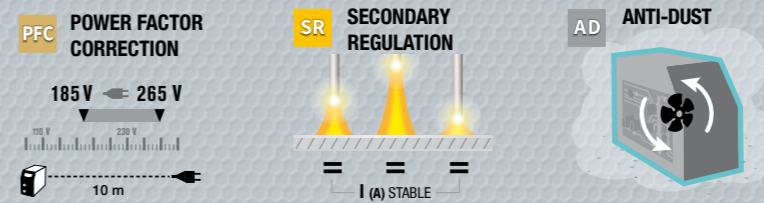

- Rings - Anneaux - Zugösen
- Start-up - Amorce - Zündung
- Hitching (I & t)
- Studs - Goujons - Gewindebolzen
- Scouring (I & t) - Décapage
- Accroche - Verklebung
- Stainless steel nails - Tiges inox
- Abbeizen
- Height - Hauteur
- Edelstahlnägel
- Arc (I & t) - Arc - Lichtbogen
- Hohe



7
languages
FR, EN, DE, SP, IT,
NL & RU



SYNERGIC DIGITAL GUNS

★★★★★ **DRAWN ARC PROCESS**
Gas protection

UNIQUE Linear Motor

FULL CONTROL

3 m, ∅ 25 mm²
included
ARCPULL
200, 350 &
COMBI ARCPULL

Adjustable

Consumables for Gun

- x2 059627
- x1 059610

GYS POT ARCPULL 350

208 · 240V · 1~
350 A ×1 MANUAL

PFC SR AD

062191

included



Manual synergic gun
3 m, 25 mm²

OPTIONS

details p.24

Weld 810
for ARCPULL 350
037489



PACKS ARCPULL 350

	Arccpull 350	Croco T400.70	Rivet box	Alu ring box 1.5 mm	Lifting rods
350 RIVET 064645	■	■	■	—	—
350 PULLER 064652	■	—	—	■	x1 180, 300, 500 mm
350 PULLER + RIVET 064669	■	■	■	■	x1 180, 300, 500 mm

GYS POT ARCPULL 700

380 · 480V · 3~
680 A ×1 MANUAL

SR IP 23

068315

included

Manual synergic gun
3 m, 50 mm²

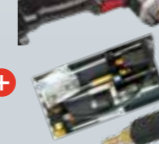

Arc Pull Rivet Box 700



Lifting rod 180 mm (x1)



Ground studs holder
∅ 6 (x1)
075368
∅ 8 (x1)
075375
∅ 10 (x1)
075382

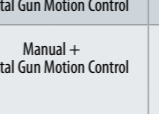

Double earth clamps
700 A, 3 m, 50 mm²
068605



ALU RING BOX
1.5 mm
(AlSpec + AlMg3 + AlMgSi)
059429



Gas protection (x1)
068346



Threaded holder
∅ 5 (x1)
076174
∅ 6 (x1)
068391

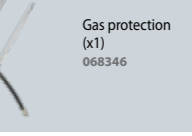
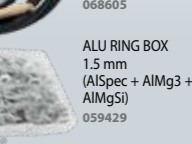

MADE IN FRANCE 60974-1	50/60 Hz	I ₂ A	SYNERGIC	TECHNOLOGY	U ₂		kW	LxWxH cm / kg				
					Acier/Steel	Alu			Power Factor Correction	Flexible Voltage	V	A
GYS POT ARCPULL 350	208 · 240V	6 m	10 · 350	Manual + Digital Gun Motion Control	■	—	20.4 · 34V	16	11.9	OK	OK	48 x 36 x 30 / 17.4
GYS POT ARCPULL 700	3x 400V 3x 480V	5 m	50 · 680	Manual + Digital Gun Motion Control	—	—	22 · 44V	20 A (D) 16 A (D)	47.8 kW 45.7 kW	OK	OK	60 x 43 x 46 / 27.8



FAST DENT PULLING

STEEL / ACIER / STAHL

EASY TOOL CONNECTION



for GYSPOT 39.02/04, PRO 230/400, EXPERT 230/400, COMBISPOT 230



051584
380 g



Rings - Anneaux - Anschweißösen

051652

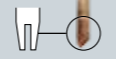

Wavy wires - Fils ondulés - Wellendraht

051669

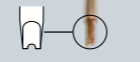

Tempering - Rétreinte - Glättwerkzeug

051676



Manual dent-pulling bar - Poignée de tirage manuel

057289



EASYGUN 051317



Box of 3 electrodes for accessories 050822



MANUSPOT = 050679



Tools set and support for DENT 600, 800, 1000, 1600, Workstation & Dentstation



FAST & EASY



MANULINER 050471

RINGMATIC 052154



included (x 50)

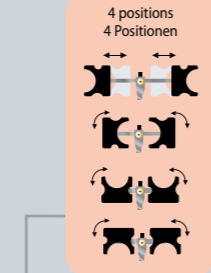

4 positions 4 Positionen

MANULINER/GUN 056831



PATENTS REGISTERED NUMBERS 001652108-0003 EUROPEAN TRADEMARK & DESIGN

Gun adapter - Adaptateur pistolet included 052499



MANU PULLER 079502



Included Alu 3 065178

Included 079830

Included Alu 4 065185

DENT AXE PULLER 080508

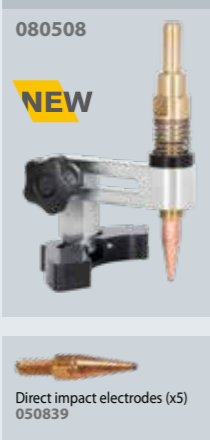

Direct impact electrodes (x5) 050839

QUICK SPOT AIR GUN V2 057340



LIGHT 920 g

QUICK SPOT AIR GUN V2 + Mini-fraiseuse - Mini-Druckluftfräser 065567



Included Tungsten drill Ø 6 mm 054172

Gun adapter - Adaptateur pistolet 052826

ALU

ARC PULLER PREMIUM 065161



Included Alu 3 065178

Included Alu 4 065185

Pads - Patins (x2) 069008

ULTRA RESISTANT No deformation

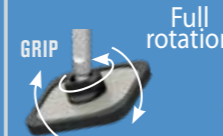

Full rotation

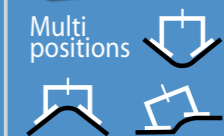

Multi positions

ARC PULLER PREMIUM PRO 072572



Included Alu 3 065178

Included Alu 4 065185

Pads - Patins (x4) 074958

ALU PULLER = 051003

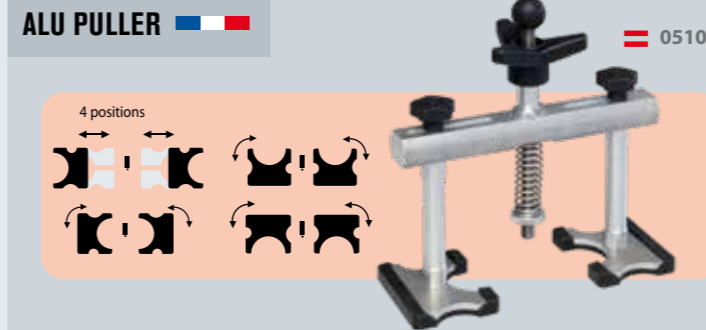

4 positions

Included Alu 1 050938
Included Alu 2 050945

Patins - Pads (x2) 060807

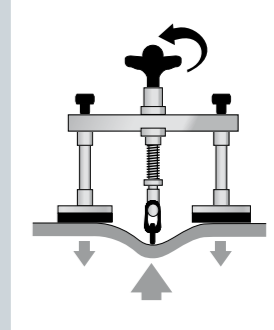

STRAIGHT LINE LAMP - Lampe ligne droite - Dentline-laser 056770



FAST PULLING RINGS - Anneaux de tirage rapide 058743 =



x5 058712

Alu 1 050938

Alu 2 050945

goujons alu - alu screws ø 4, 5 & 6 mm

Marteau à inertie 380 g 050051

ALU HAMMERS - Marteaux alu 020986



Heat gun - Décapeur thermique - Heißluftpistole

I: 100/300°C (450 W)
II: 300/650°C (1500 W)
Air flow: 450 l/min



066311

Gas hot air gun - Pistolet à air chaud autonome à gaz

Bouteille de gaz incluse, gas cylinder included



060777

Blow torch - Lampe à souder - Lötlampe

052741



Novacet + (Butane/propane/proplylene) 380 ml/220 g

HIGH QUALITY



040441

Brushes - Brosses - Bürsten - Brosses - Cepillos

044258



Thermal marking pencil - Crayon marqueur thermique

121°C / 250°F



052765

Infrared Thermometer - Thermomètre infrarouge

-50 / +380°C -58 / +716°F



052994

Freezer spray - Spray refroidisseur

-50°C 400 ml



(x 12) 048898

Heat barrier spray - Spray barrière thermique

054325



PULLING BARS

3 PRODUCT LINES

1 STANDARD

2 PREMIUM



3 PREMIUM PRO



STANDARD

Levelling lever
- Levier de débousselage
- Zughebel

050686
↓ 1.6 kg
⊗ 79 x 12 x 17 cm / 1.9 kg

PATENTS REGISTERED NUMBERS
001652108-0002
EUROPEAN TRADEMARK & DESIGN

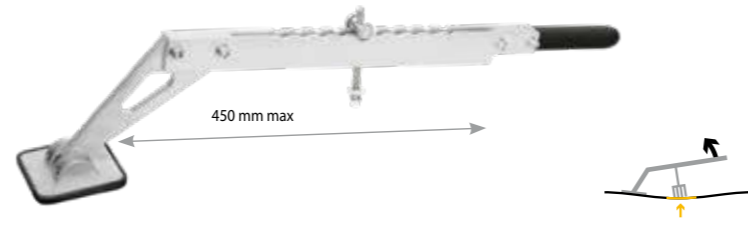

Double action levelling bar
- Barre de débousselage double action
- Zughebelbrücke

053564
↓ 2.5 kg
⊗ 77 x 12 x 13 cm / 3.2 kg

Licensed by
BETAG.Innovation

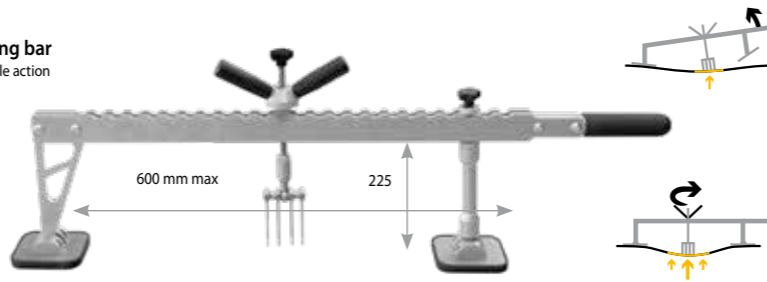

Levelling bar
- Barre de débousselage
- Zugbrücke

050693
↓ 3.4 kg
⊗ 87 x 17 x 19 cm / 4 kg

Licensed by
BETAG.Innovation

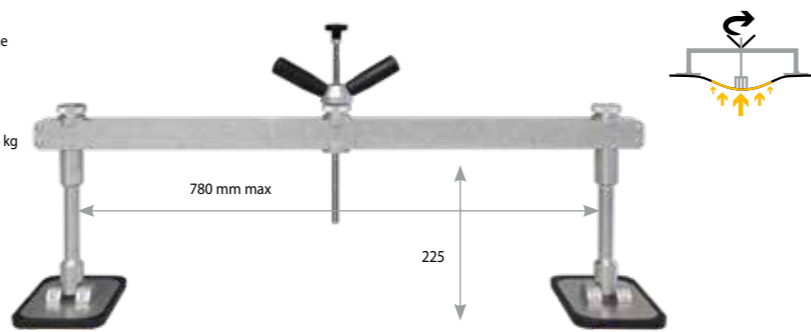

Reinforced scissoring bar
- Barre de tirage renforcée
- Scherenzugbrücke

050716
↓ 5.1 kg
⊗ 87 x 17 x 18 cm / 5.9 kg

PATENTS REGISTERED NUMBERS
001652108-0001
EUROPEAN TRADEMARK & DESIGN

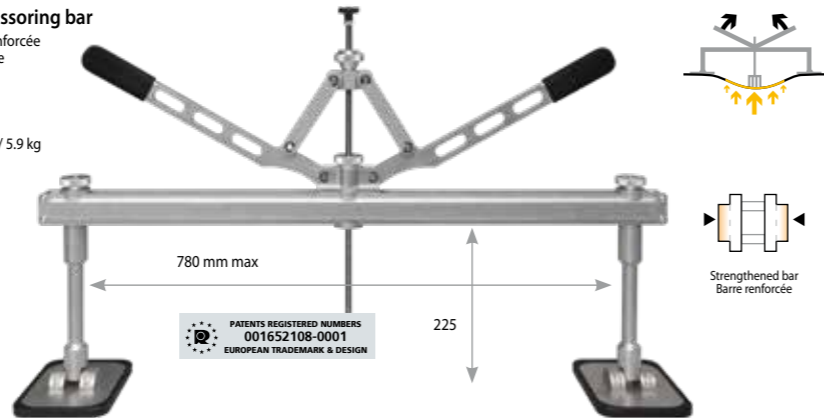

SLIDE & LOCK

Removable system : pads and pulling systems
Système amovible : patins et chariots de tirage

FEET



PULLING SYSTEM

only for 059313



LIGHTWEIGHT

Léger



GRIP 360

360° pads with grip
Patins à frein orientables à 360°



X-CROSS

Possibility of crossing the bars
Possibilité de croiser les barres

PREMIUM

Premium levelling lever
- Levier de débousselage Premium
- Premium Zughebel

059290
↓ 1.6 kg
⊗ 100 x 16 x 17 cm / 2.2 kg

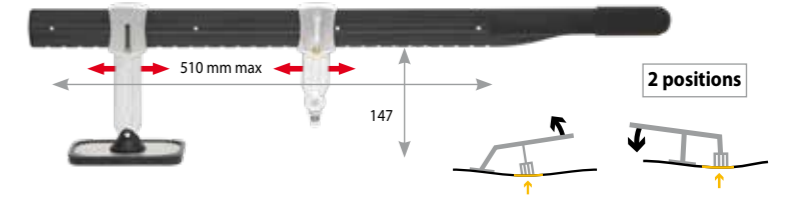

Premium levelling bar
- Barre de débousselage Premium
- Premium Zugbrücke

059306
↓ 2.8 kg
⊗ 79 x 30 x 13 cm / 3.2 kg

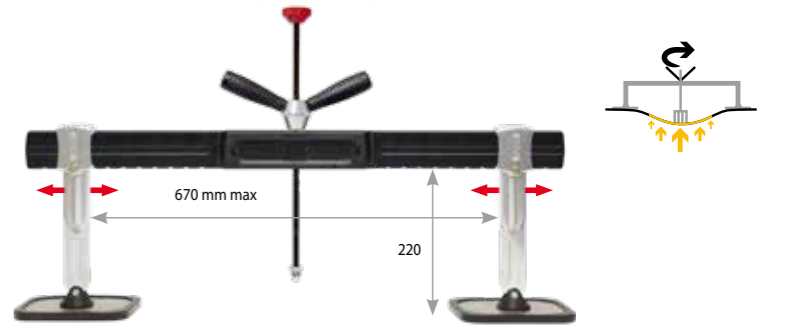

Premium scissoring bar
- Barre de tirage Premium
- Premium Scherenzugbrücke

058996
↓ 3.1 kg
⊗ 87 x 16 x 18 cm / 3.9 kg

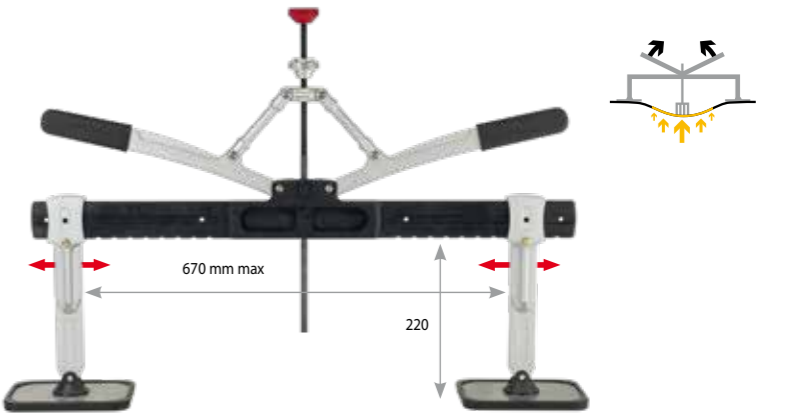

Premium 1200 scissoring bar
- Barre de tirage 1200 renforcée Premium
- Premium Scherenzugbrücke 1200

059313
↓ 5.6 kg
⊗ 127 x 26 x 9 cm / 6.2 kg

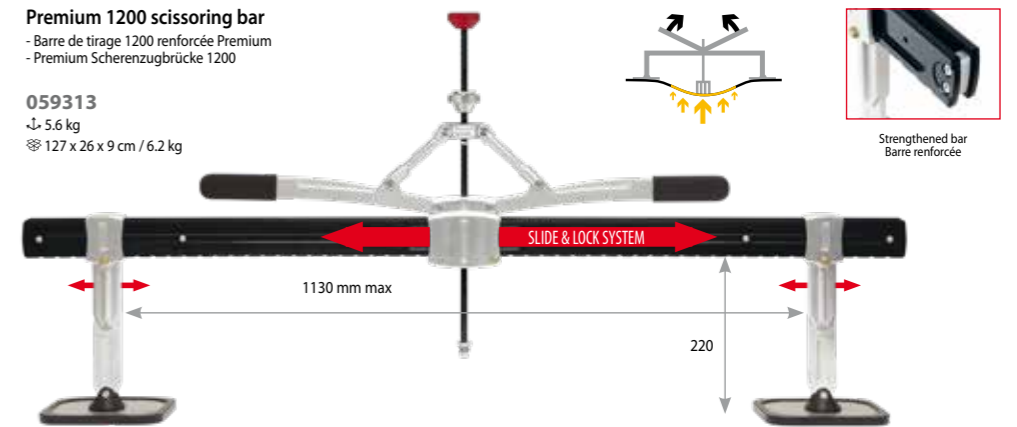

OPTIONS

Reinforced bar 1200 mm - Barre renforcée
051171
1200 mm

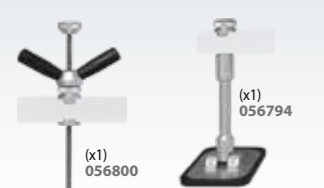
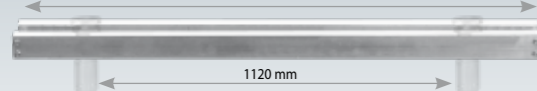

STANDARD



STANDARD

PREMIUM (LONG FEET NEEDED)

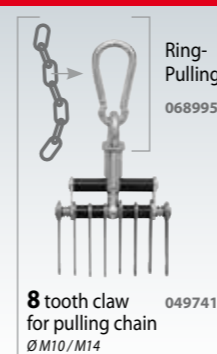
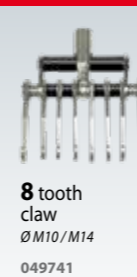

PREMIUM

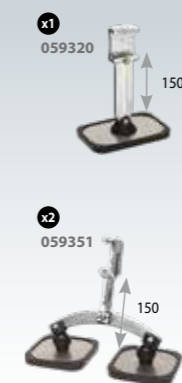

OPTIONS

☆☆☆ SUPER ERGONOMIC



QUICK HOOK

2 teeth hook PREMIUM PRO 072664	4 tooth claw PREMIUM PRO 072640	8 tooth claw PULLING CHAIN 080546
3 teeth hook PREMIUM PRO 072671	6 tooth claw PREMIUM PRO 072657	8 tooth claw PREMIUM PRO 080539



EASY REMOVABLE PULLING SYSTEM

071650 51 x 21 x 11 cm / 0.9 kg	072633 79 x 61 x 11 cm / 5.2 kg
072312 51 x 21 x 11 cm / 1.6 kg	

SLIDE & LOCK

Removable system - pads and pulling systems
Système de patins et chariots de tirage amovibles

PULLING SYSTEM

FEET

PREMIUM PRO

Premium Pro Levelling lever
- Levier de débousselage Premium Pro
- Premium Pro Zughebel

072619
1.6 kg
87 x 17 x 18 cm / 2.3 kg

2 positions

510 mm max

147

QUICK HOOK

Premium Pro Levelling bar 900mm / Single feet
- Barre de débousselage Premium Pro 900 mm
- Premium Pro Zugbrücke 900 mm

071643
120 x 26 x 8 cm / 4.4 kg
3.8 kg

SLIDE & LOCK SYSTEM

840 mm max

220

QUICK HOOK

Premium Pro Levelling bar 900mm / Double feet
- Barre de débousselage Premium Pro 900 mm
- Premium Pro Zugbrücke 900 mm

080102
3.8 kg

NEW

SLIDE & LOCK SYSTEM

840 mm max

220

QUICK HOOK

Premium Pro Scissoring bar 900mm
- Barre de tirage Premium Pro 900 mm
- Premium Pro Scherenzugbrücke 900 mm

072305
103 x 30 x 13 cm / 5.2 kg
4.5 kg

840 mm max

220

QUICK HOOK

Premium Pro Scissoring bar 1150 mm
- Barre de tirage Premium Pro 1150 mm
- Premium Pro Scherenzugbrücke 1150 mm

072626
124 x 7 x 7 cm / 3.1 kg

1184 mm

GRIP 360

GRIP 360+

360° pads with grip
Patins à frein orientables à 360°

MULTIPLE PULLING SYSTEM

Additional removable pulling systems
Chariots de tirage amovible supplémentaire

STRENGTHENED (DOUBLE) BAR

Improved mechanical resistance
Résistance mécanique renforcée

X-CROSS

Possibility of crossing the bars
Possibilité de croiser les barres

OPTIONS

Single foot
- Pied simplet
- Fuß

x1 059320

x2 061293

150

220

Double foot levelling bar
- Pied double patin
- Doppelfuß

x1 072688

x2 059375

150

270

220

059351

PREMIUM BAR SMARHAND

for Premium & Premium Pro
072480





DENT PULLING WORKSTATIONS

A COMPLETE SOLUTION
UNE SOLUTION COMPLÈTE
KOMPLETTLÖSUNGEN

Compatibility

SPOT	Dent 600	Dent 1000	Universal 800	Weld 810	Weld 910	Dent 1600	Dent 1600 WD	Dentstation Pro WD
2600, 2700	✓	✓	✓	✓		✓		✓
34.02/04	✓	✓	✓	✓		✓		✓
39.02/04	✓	✓	✓	✓		✓		✓
PRO 230/400	✓	✓	✓	✓		✓		✓
EXPERT 230/400	✓	✓	✓	✓		✓		✓
ALU PRO FV	✓	✓	✓			✓		✓
COMBI 230 E.PRO						✓		✓
ARCPULL 200/350				✓	✓	✓		✓
COMBI ARCPULL						✓		✓
ARCPULL 700				✓	✓	✓		✓

Universal 800
↕ 83 x 48 x 60 cm
17,6 kg
☞ 15 x 52 x 80 cm
18,1 kg
051331

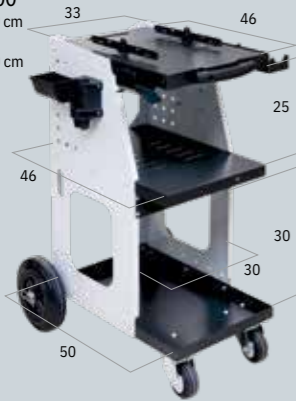

Weld 810
↕ 84 x 50 x 77 cm
20,1 kg
☞ 14 x 80 x 51 cm
21,6 kg
037489

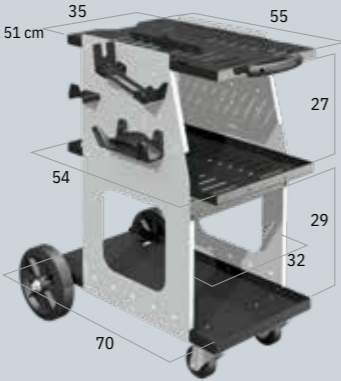

Weld 910
↕ 84 x 52 x 89 cm
25 kg
☞ 22 x 80 x 52 cm
27 kg
070967

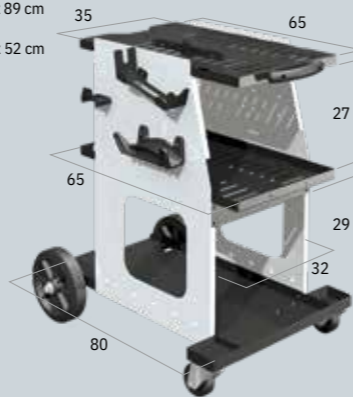

Dent 1600
↕ 69 x 161 x 70 cm
/ 35,8 kg
☞ 103 x 22 x 66 cm
/ 38,7 kg
072596

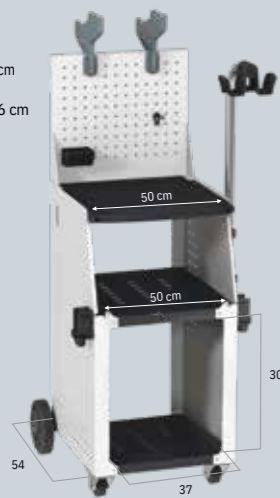

Dent 1600 WD
↕ 71 x 161 x 70 cm
/ 49,5 kg
☞ 103 x 22 x 66 cm
/ 52,4 kg
072169



Dentstation Pro WD
↕ 71 x 161 x 90 cm
/ 65 kg
☞ 120 x 28 x 80 cm
/ 68,5 kg
072800



4 m³ support
for Dent 1600 /
1600 WD &
Dentstation Pro WD
059665



Cable support for
Spot 800, 1600
& Dentstation
Pro WD
052284



Protection cover - Housse de protection
- Schutzhaube
for Universal 800
062733
for Spot 1600 & Dent 1600
048881
for Dentstation Pro
059870

CHARIOTS / TROLLEYS

Dent 600
↕ 44 x 62 x 35 cm / 6,9 kg
☞ 60 x 14 x 39 cm / 7,4 kg
072831



Dent 1000
↕ 44 x 95 x 35 cm / 9,3 kg
☞ 60 x 14 x 39 cm / 9,9 kg
072848

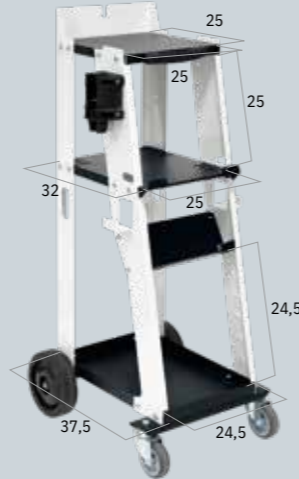

EASYLINER



EASYLINER 39.02

EASYLINER PRO 230

PROLINER



PROLINER 39.02
PROLINER 39.04

PROLINER PRO 230
PROLINER PRO 400

PROLINER ALU PRO FV

PROLINER ARCPULL 200

STEEL / ACIER / STAHL



GYSPOT
(guns & consumables included)

STEEL / ACIER / STAHL



GYSPOT
(guns & consumables included)

ALU



GYSPOT
(guns & consumables included)

39.02	PRO 230	39.02	PRO 230	ALU PRO FV	ARCPULL 200
053618 ☞ : 058521	072398	035775	035799	035836	065260



INCLUDED ACCESSORIES



DENT 1000
072848

Dent box easy
053632

INCLUDED ACCESSORIES



UNIVERSAL 800
051331
+ Cable support
052284

Dent box easy
050037



Levelling bar double action
053564

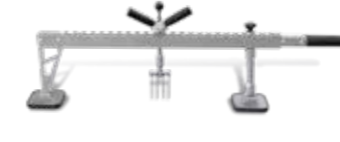

Levelling bar double action
053564

INCLUDED ACCESSORIES



UNIVERSAL 800
051331
+ Cable support
052284

INCLUDED ACCESSORIES



Weld 810
037489
+ Cable support
052284



Alu puller
051003



Arc puller premium
065161

SPEEDLINER STANDARD

COMPLETE
SYSTEM



PRO 230, 400 EXPERT 200, 230, 400 COMBI 230 E.PRO ARCPULL 200 + PRO 230, 400 ARCPULL 200 + EXPERT 200, 230, 400 ALU PRO FV

STEEL / ACIER / STAHL



GYSPOT
(guns & consumables included)



GYSPOT
(guns & consumables included)



GYSPOT
(guns & consumables included)



GYSPOT
(guns & consumables included)

PRO 230 074446	EXPERT 200 074460	COMBI 230 E PRO 074491	ARCPULL 200 + PRO 230 074507	ARCPULL 200 + EXPERT 200 074521	ALU PRO FV 074552
PRO 400 074453	EXPERT 230 074477		ARCPULL 200 + PRO 400 074514	ARCPULL 200 + EXPERT 230 074538	
	EXPERT 400 074484			ARCPULL 200 + EXPERT 400 074545	

INCLUDED ACCESSORIES

DENT 1600 072596	Cable support 052284	Levelling bar 850 mm 050693 052451	
Magnetic earth 049666	Multihook heads 049758+049734	Levelling bar 050693	
Manuspot 050679	Dent box consumables 051515 3 lifting rods 050792	Ringmatic 052154	
Alu puller 051003	Cable support 052284	Arc puller premium 065161	Cable support 052284 + 4 m support 059665

INCLUDED ACCESSORIES

DENT 1600 072596	Cable support 052284
Levelling bar 850 mm 050693	
Alu hammers 020986	Set of pencil punches with 6 teflon tips 052888
Multihook heads 049758	Alu puller 051003
Stainless steel brush 044258 Alu Box 05 & 6 048195	Infrared Thermometer 052994 Hot air gun 650°C 066311

without generator (excluded Ringmatic) 035058

SPEEDLINER PREMIUM

★★★★
COMPLETE SYSTEM



PRO 230, 400 EXPERT 200, 230, 400 COMBI 230 E.PRO ARCPULL 200 + PRO 230, 400 ARCPULL 200 + EXPERT 200, 230, 400 ARCPULL 200, 350



STEEL / ACIER / STAHL



GYSPOT
(guns & consumables included)



GYSPOT
(guns & consumables included)



GYSPOT
(guns & consumables included)

ALU



GYSPOT
(guns & consumables included)

PRO 230 073883	EXPERT 200 073906	COMBI 230 E PRO 073968	COMBI ARCPULL 074569	ARCPULL 200 + PRO 230 073975	ARCPULL 200 + EXPERT 200 073913	ARCPULL 200 073999	ARCPULL 350 074934
PRO 400 073890	EXPERT 230 073920			ARCPULL 200 + PRO 400 073982	ARCPULL 200 + EXPERT 230 073937	077317 (without HOT AIR GUN)	
	EXPERT 400 073944				ARCPULL 200 + EXPERT 400 073951		

INCLUDED ACCESSORIES

DENT 1600 WD 072169	Cable support 052284	Premium levelling bar 720 mm 059306	
Hook head 049758 + 059658 + 059382	Premium levelling lever 059290		
Magnetic earth 049666	Manuspot 050679	Dent box consumables 051515 + 3 lifting rods 050792	Manual pulling handle 057289 Ringmatic 052154
Fast pulling rings (x5) 058712 + Alu puller 051003 + Cable support 052284		4 m³ support 059665 Arc puller premium 065161 + Cable support 052284	Arc puller premium 065161
Cable support 052284		4 m³ support 059665	

INCLUDED ACCESSORIES

DENT 1600 WD 072169 Cable support 052284	Alu Ring Box 1 mm 059412
Alu Ring Box 1,5 mm 059429	Premium 2-teeth hook 059382
Arc puller premium 065161	Premium levelling bar 720 mm 059306
Alu hammers 020986	Infrared Thermometer 052994
Hot air gun 650°C 066311	
Set of pencil punches with 6 teflon tips 052888	
3 lifting rods 050792	Ring holder 059610
Stainless steel brush 044258	4 m³ support 059665

SPEEDLINER PREMIUM PRO



PRO 230, 400



EXPERT 200, 400
+ ARCPULL 200, 350



COMBI ARCPULL



ARCPULL 200, 350



STEEL / ACIER / STAHL



GYSPOT
(guns & consumables included)

ALU + STEEL / ACIER / STAHL



GYSPOT
(guns & consumables included)



GYSPOT
(guns & consumables included)

ALU



GYSPOT
(guns & consumables included)

EXPERT 230	EXPERT 400	EXPERT 400 + ARCPULL 200	EXPERT 400 + ARCPULL 350	COMBI ARCPULL	ARCPULL 200	ARCPULL 350
080201	080218	080232	080249	080225	080256	080263
		EXPERT 200 + ARCPULL 200				
		080553				

INCLUDED ACCESSORIES

Dent 1600 WD 072169	Premium Pro levelling bar 900 mm 071643
Ringmatic 052154	Manuspot 050679
Manual pulling handle 057289	3 lifting rods 050792 Dent box consumables 051515
Premium Pro teeth hook 072671 + 072664 + 072640	Magnetic earth 049666
Cable support 052284 4 m³ support 059665 Arc Puller Premium Pro 072572	4 m³ support 059665
Arc Puller Premium Pro 072572	Ring holder 059610 Alu Ring Box 1.5 mm 059429
Cable support 052284 4 m³ support 059665 Arc Puller Premium Pro 072572	4 m³ support 059665

INCLUDED ACCESSORIES

Dent 1600 WD 072169	Alu Ring Box 1 mm 059412 Alu Ring Box 1.5 mm 059429
Ring holder 059610	4 m³ support 059665
Premium Pro levelling bar 900 mm 071643	Set of pencil punches with 6 teflon tips 052888
Arc Puller Premium Pro 072572	Alu hammers 020986
Infrared Thermometer 052994 Hot air gun 650°C 066311	230V
Stainless steel brush 044258	3 lifting rods 050792

DENTSTATION STANDARD



39.02, 39.04 PRO 230, 400 EXPERT 200, 230, 400 COMBI 230 E.PRO ARCPULL 200 + PRO 230, 400 ARCPULL 200 + EXPERT 200, 230, 400

COMPLETE SYSTEM

STEEL / ACIER / STAHL



GYSPOT
(guns & consumables included)

ALU + STEEL / ACIER / STAHL



GYSPOT
(guns & consumables included)

GYSPOT
(guns & consumables included)

39.02	PRO 230	EXPERT 200	COMBI 230 E PRO	ARCPULL 200 + PRO 230	ARCPULL 200 + EXPERT 200
078161	078208	078321	078529	078222	078338
39.04	PRO 400	EXPERT 230		ARCPULL 200 + PRO 400	ARCPULL 200 + EXPERT 230
078185	078260	078369		078284	078384
		EXPERT 400			ARCPULL 200 + EXPERT 400
		078444			078468

INCLUDED ACCESSORIES

<p>Dentstation Pro WD 072800 Fixing kit 051362</p>	<p>Double pads 050723</p>	<p>Levelling bar 850 mm 050693</p>	<p>Scissoring bar 050716</p>
<p>Magnetic earth 049666</p>	<p>Multihook heads 049758 +049734 +049741</p>	<p>Levelling lever 050686</p>	<p>Strengthened bar 1200 mm 051171 Extensions (x2) 052451</p>
<p>Fast pulling rings (x5) 058712 + Alu puller 051003</p>	<p>Cable support 052284</p>	<p>Arc puller premium 065161</p>	<p>Cable support 052284 + 4 m³ support 059665 + Flanges (x 2) 062146</p>

DENTSTATION PREMIUM



PRO 230, 400



EXPERT 200, 230, 400



COMBI 230 E.PRO
COMBI ARCPULL



ARCPULL 200
+ PRO 230, 400

★ ★ ★ ★
COMPLETE
SYSTEM

ARCPULL 200
+ EXPERT 200, 230, 400

STEEL / ACIER / STAHL



GYS SPOT
(guns & consumables included)

ALU + STEEL / ACIER / STAHL



GYS SPOT
(guns & consumables included)



GYS SPOT
(guns & consumables included)

PRO 230 078239	EXPERT 200 078345	COMBI 230 E PRO 078543	COMBI ARCPULL 078567	ARCPULL 200 + PRO 230 078253	ARCPULL 200 + EXPERT 200 078352
PRO 400 078291	EXPERT 230 078406			ARCPULL 200 + PRO 400 078314	ARCPULL 200 + EXPERT 230 078420
	EXPERT 400 078482				ARCPULL 200 + EXPERT 400 078505

INCLUDED ACCESSORIES

x6 Dentstation Pro WD 072800 Fixing kit 051362	x2 Manuspot 050679	Premium levelling bar 720 mm 059306	Premium levelling lever 059290
Hook head 049734 + 059658 + 059382	Premium scissoring bar 720 mm 058996	Premium scissoring bar 1200 mm 059313	
Magnetic earth 049666	Premium double pads support 150 mm (x2) 059351 + 220 mm (x2) 059375	Dent box consumables 051515 3 lifting rods 050792 Empty box 320x113mm	Manual pulling handle 057289
		Ringmatic 052154	

Fast pulling rings (x5) 058712 Alu puller 051003 Cable support 052284	Cable support 052284 4 m² support 059665 Flanges (x 2) 062146 Arc puller premium 065161	Arc puller premium 065161	Cable support 052284 4 m² support 059665 Flanges (x 2) 062146
--	--	------------------------------	--

DENTSTATION PREMIUM PRO



EXPERT 230, 400



COMBI ARCPULL



EXPERT 400
+ ARCPULL 200, 350



ARCPULL 200, 350

STEEL / ACIER / STAHL



1 BOX GYSPOT (guns & consumables included)

ALU + STEEL / ACIER / STAHL



1 BOX GYSPOT (guns & consumables included)

ALU



1 BOX GYSPOT (guns & consumables included)

EXPERT 230	EXPERT 400	EXPERT 400 + ARCPULL 200	EXPERT 400 + ARCPULL 350	COMBI ARCPULL	ARCPULL 200	ARCPULL 350
080133	080140	080164	080171	080157	080461	080478

INCLUDED ACCESSORIES



1 BOX Dentstation Pro WD 072800



Premium pro levelling bar 900mm 071643



Premium pro levelling lever 072619
Premium pro bar 1184 mm 072626



Manuspot 050679

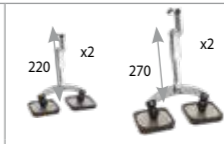

x2 220 x2 270
(x2) 059375 + (x2) 072688



072664 + 072671 + 072640 + 072657



071650 + 072312
Double padded feet 270 mm 072688

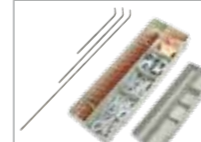

Dent box consumables 051515
3 lifting rods 050792
Empty box 320x113mm



Magnetic earth 049666
Ringmatic 052154
Manual pulling handle 057289

1 BOX STEEL ACCESSORIES PACK V2 080126



Cable support 052284



4 m³ support 059665



Arc Puller Premium Pro 072572

1 BOX ALU ACCESSORIES PACK 073838



Ring holder 059610
Alu Ring Box 1.5 mm 059429

INCLUDED ACCESSORIES



1 BOX Dentstation Pro WD 072800



Premium pro levelling bar 900mm 071643 (x2) 059375



072664 + 072640 + 071650
Alu Ring Box 1 mm 059412
Alu Ring Box 1.5 mm 059429



Alu hammers 020986



Arc Puller Premium Pro 072572



Set of pencil punches with 6 teflon tips 052888



3 lifting rods 050792
Ring holder 059610



Stainless steel brush 044258
Infrared Thermometer 052994
Hot air gun 650°C 06631



4 m³ support 059665

1 BOX ARCPULL ACCESSORIES PACK 080485



PULLING SYSTEMS



AIRFIX DRAW ALIGNER	39
DRAW ALIGNER	40
FRAME STRAIGHTENING	42



DRAW ALIGNER

AIRFIX DRAW ALIGNER

Air 5-8 bars

077379



350 kg Uniform pulling force

Force de tirage uniforme
Gleichmäßige Zugkraft
Forza di spinta uniforme



NEW



Designed for

- ★ Time saving
- ★ Maximum grip
- ★ Durability

Ground anchor by suction Fast installation

Ancrage au sol par aspiration :
installation rapide
Verankerung durch Vakuumbildung -
schnell einsatzfähig
Ancoraggio a terra: installazione rapida

Precision

All directions

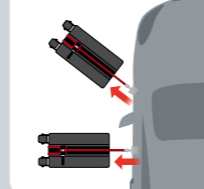

Down-pulling

Rocker panel
- Bas de caisse
- Schweller
- Sottoporta



4 pads

Seal protection Perfect stability

4 patins : protection du joint, stabilité parfaite
4 Pads: Dichtungsschutz, perfekte Stabilität
4 piedini: protezione sigillata, perfetta stabilità



Seal - Joint - Rahmen - Guarnizione

Quick & easy set up



Compact
& light
31 kg

Low noise

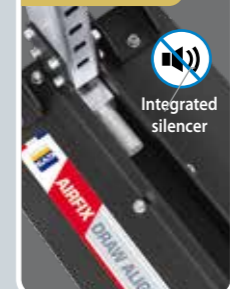

Smart maintenance

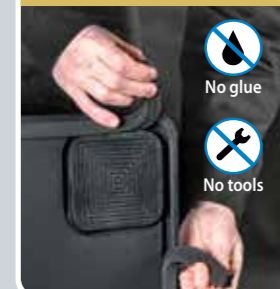

4 Pads - Patins (x2)
069008

Plate seal - Joint de plaque
079571



PULLING SYSTEMS

**DRAW ALIGNER**

Draw ligner - Équerre de tirage - Schnellausbeul-Richtausleger
052475

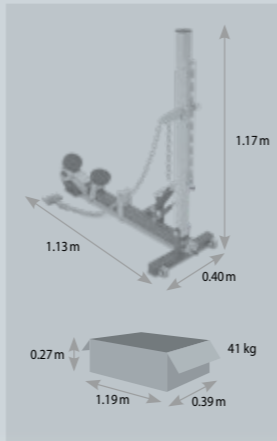
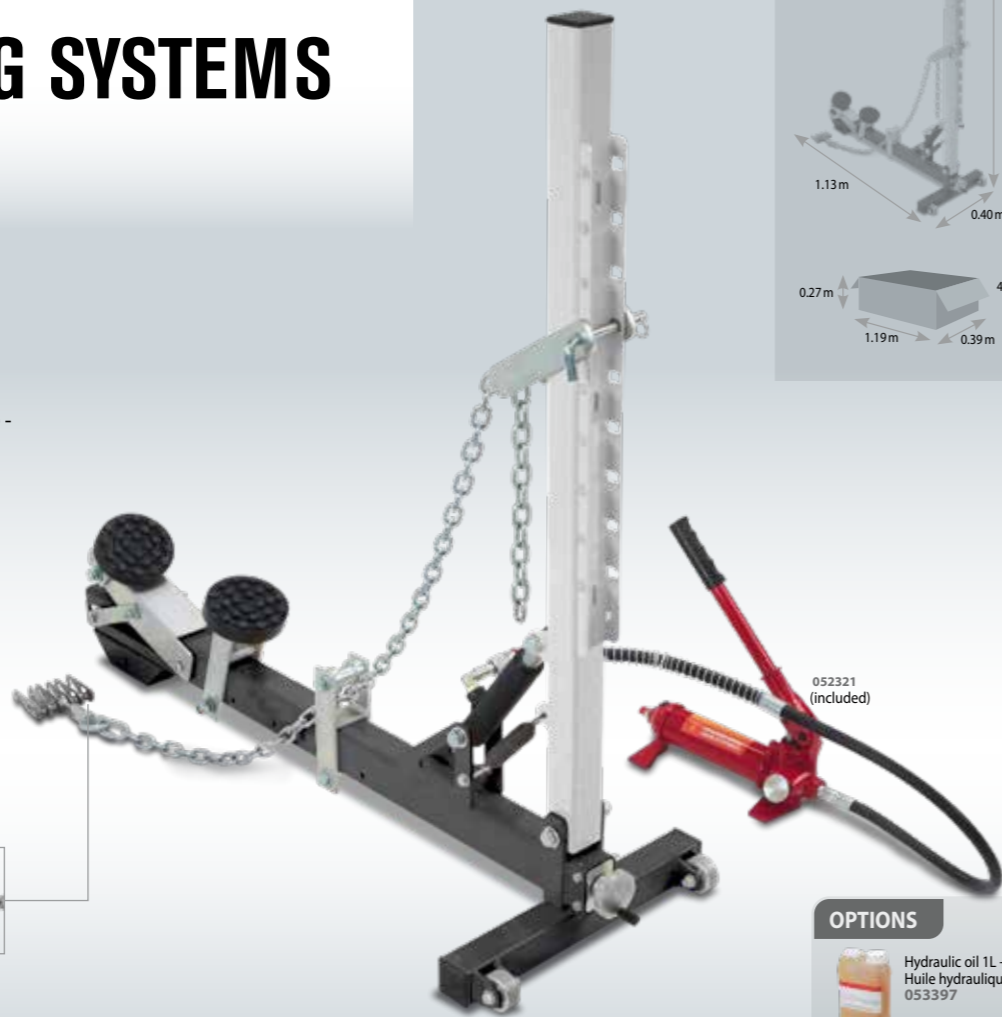
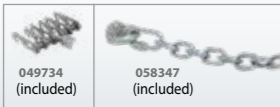
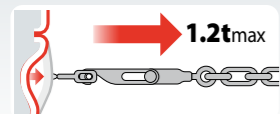
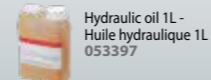
**OPTIONS****INCLUDED**

Wedge for rocker panel - C le pour bas de caisse

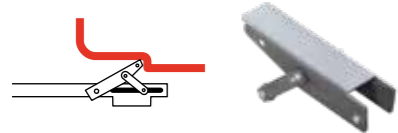

Pads kit for rocker panel - Kit patins pour bas de caisse

**OPTIONS**

Rocker panel arms for draw aligner - Bras de bas de caisse - Abst tzttraverse f r Richtausleger

052581

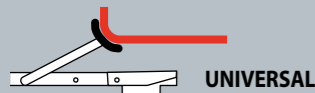
**UNIVERSAL****DRAW ALIGNER PRO**

069244

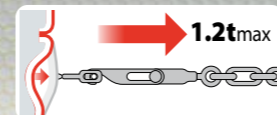

049734 (included)

058347 (included)

**OPTIONS****INCLUDED**

Plate under the wheel - C le sous roue
Compatible with Draw Aligner & Draw Aligner Pro

076693



Wedge for rocker panel - C le pour bas de caisse

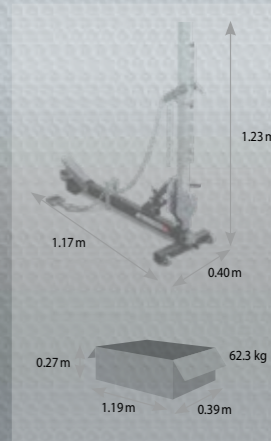
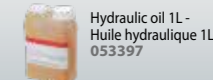

Rocker panel arms and stabilisation bar - Kit bras de bas de caisse et barre de stabilisation

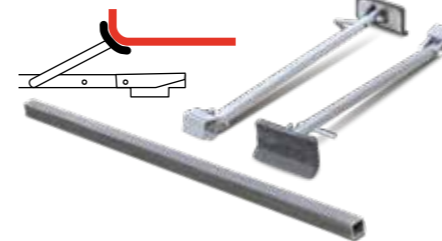
**OPTIONS**

Pads kit for rocker panel - Kit patins pour bas de caisse

071278



SMART PULLER SILVER PULLING SYSTEM

- Système de tirage Smart puller silver - Schnellausbeul-Richtausleger Smart puller silver

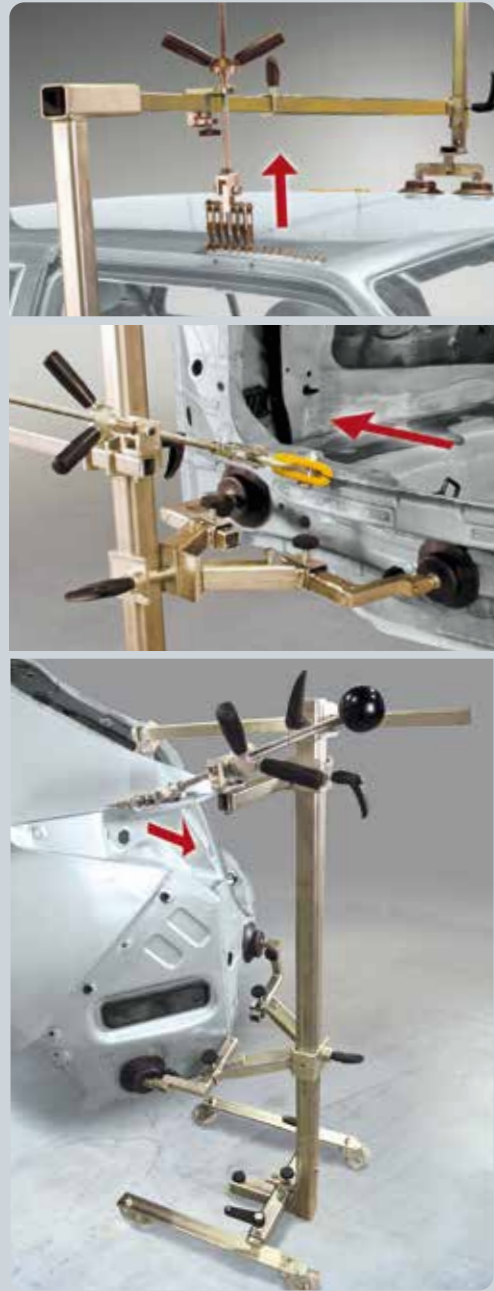

054820

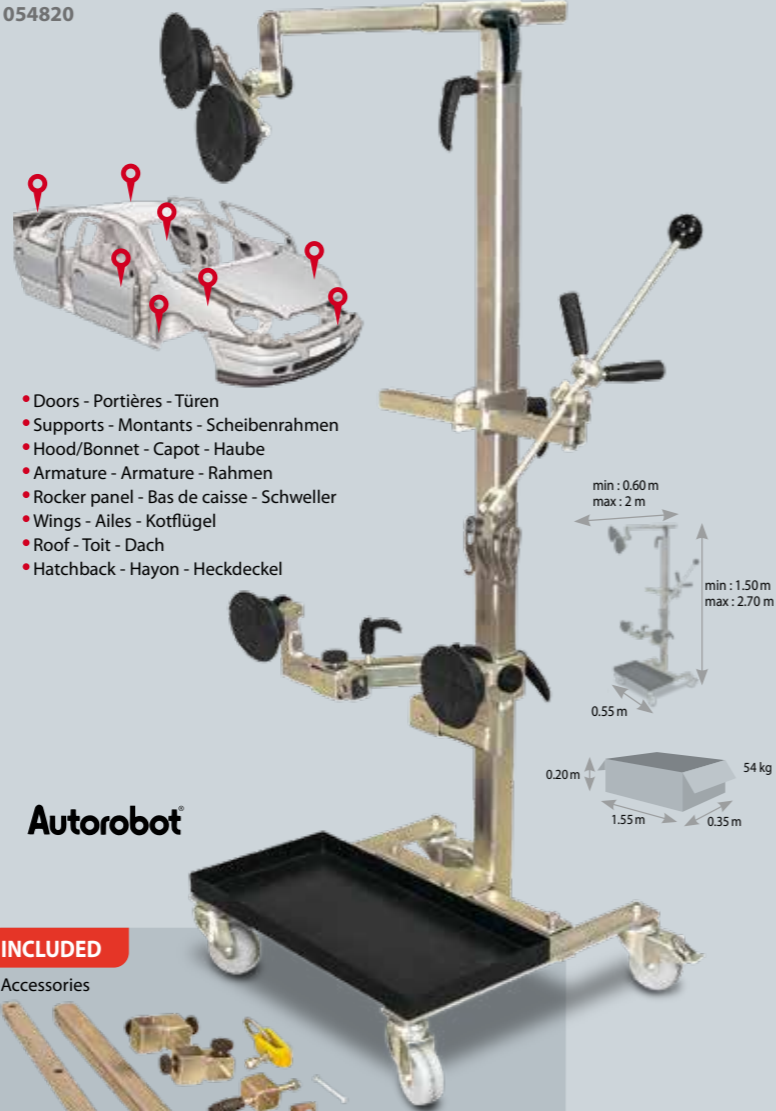

- Doors - Portières - Türen
- Supports - Montants - Scheibenrahmen
- Hood/Bonnet - Capot - Haube
- Armature - Armature - Rahmen
- Rocker panel - Bas de caisse - Schweller
- Wings - Ailes - Kotflügel
- Roof - Toit - Dach
- Hatchback - Hayon - Heckdeckel

min: 0.60 m
max: 2 m

min: 1.50 m
max: 2.70 m

0.55 m

0.20 m

1.55 m

0.35 m

54 kg

Autorobot

INCLUDED

Accessories

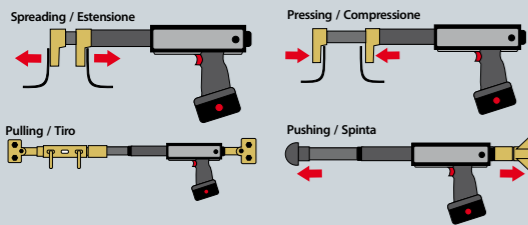

Applications / Applicazioni

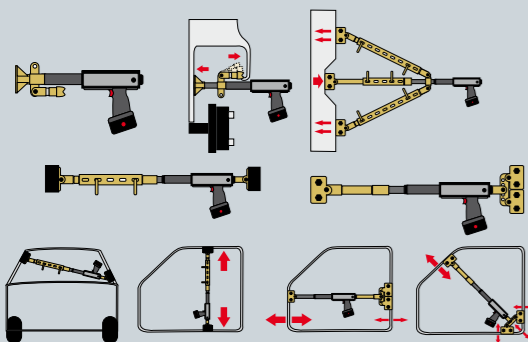

ELECTRO POWER - Zug-Druckpresse

Non commercialisable en France

OPTION

Pince écarteur 079496

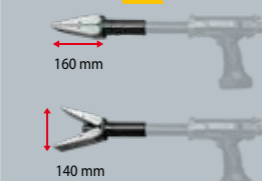

with accessories: 057425

PULLING POWER: 5 Ton.
PUSHING POWER: 5 Ton.
PISTON
STROKE: 130 mm



INCLUDED

Standard kit : 425x620x210 mm
Standard kit
Total weight: 18 kg

057401

INCLUDED

Accessories kit : 425x620x150 mm
Accessories kit
Total weight: 20 kg

057418

Li-Ion battery (included) 058514

HYDRAULIC CYLINDER KIT - Coffret vérin hydraulique - Hydraulischer Drucksatz

MADE IN CHINA

BASIC 4T
052345



BASIC 10T
052338



PRO 4T
057432



PRO 10T
057449



OPTIONS



Hydraulic oil 1L - Huile hydraulique 1L 053397

ANCHOR BAR - Barre d'ancrage - Türspanner

MADE IN TAIWAN

053045



053052



MEASURING TOOLS - Mesures - Vermessung

BODYMETER, Mechanical measurements

052130

250 > 2230 mm



GYSMETER, Electronic measurements

052093

Measuring report

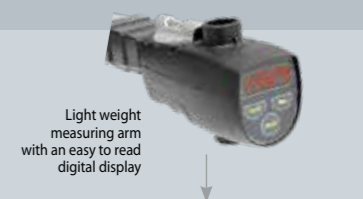
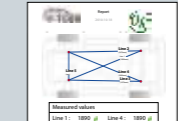

Light weight measuring arm with an easy to read digital display

400 > 2650 mm

SWIVEL CLAMP
- Pince pivotante

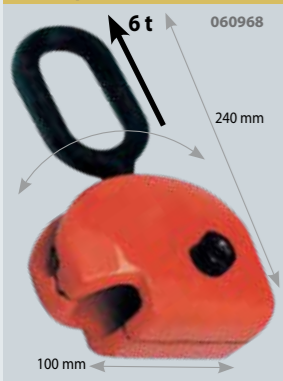

PULL CLAMPS - Pincas de tirage - Ziehwerkzeuge

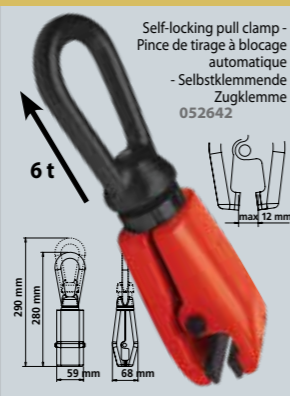

PULL HOOK - Crochet de tirage - Ziehwerkzeuge

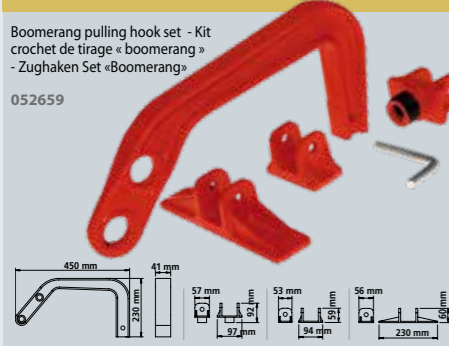

ARCH HOOKS - Passage de roue

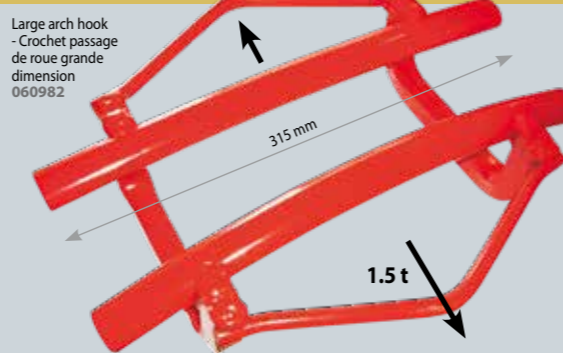
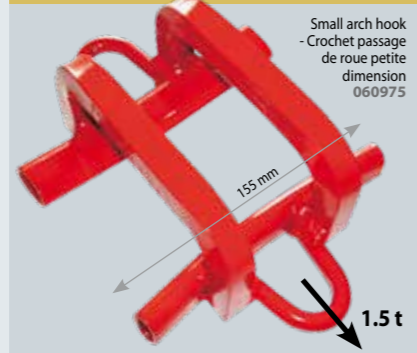

PULLING CHAIN - Chaînes de tirage - Ziehwerkzeuge

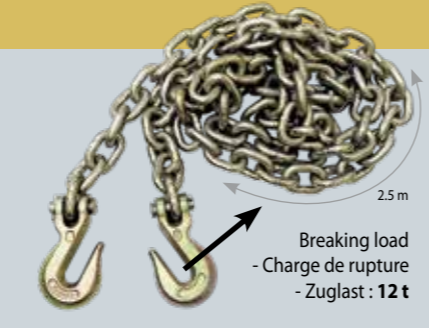
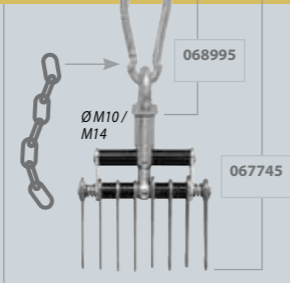
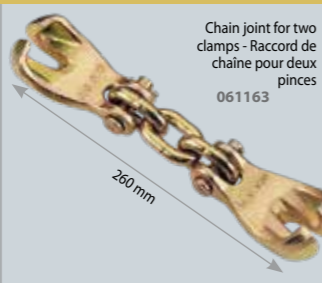
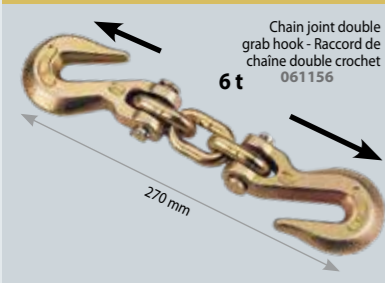

WIDE PULL CLAMPS - Pincas de tirage larges

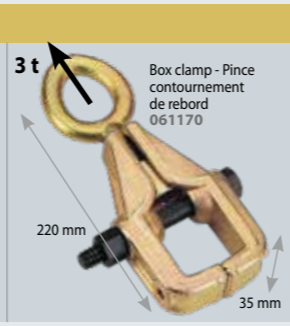
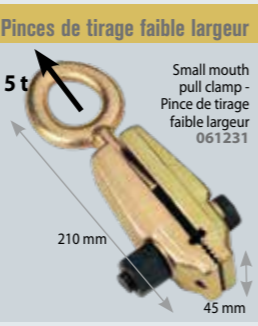
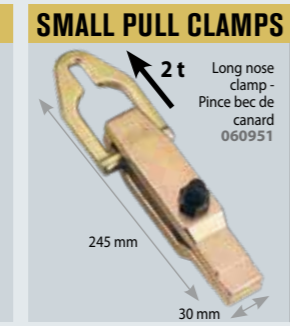
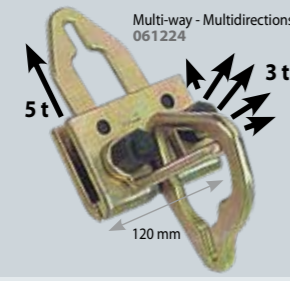
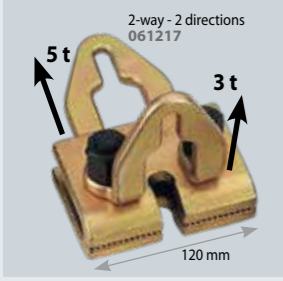

MULTIPLE PULL CLAMP
- Pince de tirage multiple

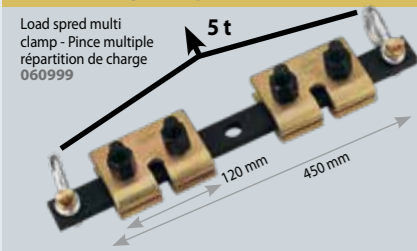

45 MM SCISSORS CLAMP
- Pince ciseaux largeur 45 mm

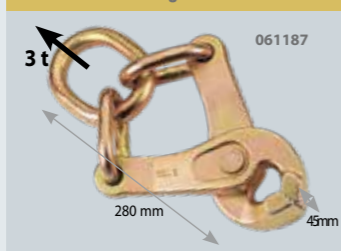

90 DEGREE CORNER CLAMP
- Pince de tirage pour angle 90°



C TYPE CLAMP
- Pince de tirage type C



INERTIA HAMMER KIT - Kit marteau à inertie - Ausziehhammer kit

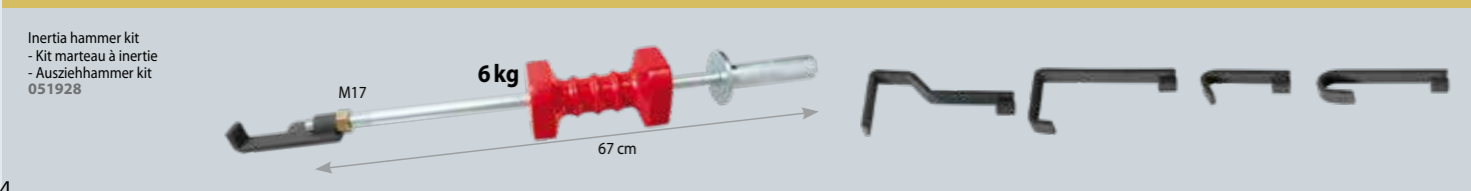

SMART SATELLITE - Satellite intelligent- Satellite Komplett-Kit

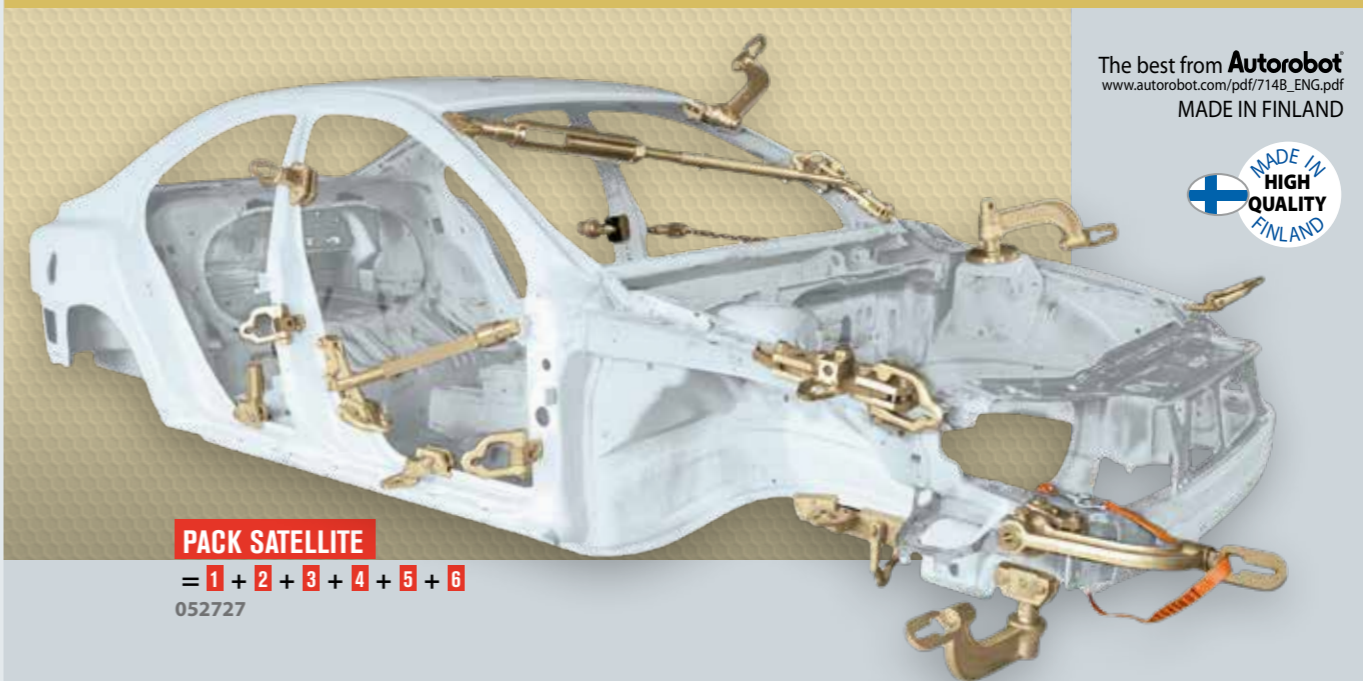

The best from **Autorobot**
www.autorobot.com/pdf/7148_ENG.pdf
MADE IN FINLAND



PACK SATELLITE
= 1 + 2 + 3 + 4 + 5 + 6
052727

1 SATELLITE
- Satellite - Satellite Basisbügel-Set



2 KIT MAC PHERSON (A)
- Mac Pherson Kit - Befestigungs-Kit-Federbein (McPherson)

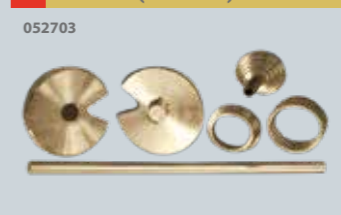

3 BARRE POUR TIRER/POUSSER
- Push/Pull Bar - Zug/Druck-Stangenset



4 SATELLITE (B)
- Bügelverlängerung

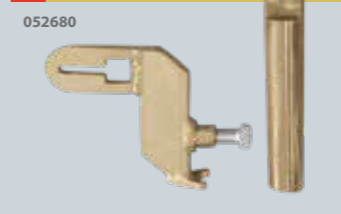

5 SANGLE DE SÉCURITÉ
- Safety Strap - Sicherungsgurt

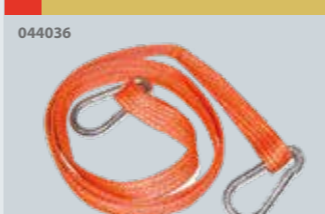

6 DOUBLE PINCE SATELLITE (C)
- Double Clamp Satellite - Satellite Doppelklemme



PINCE DE TIRAGE MULTI-USAGE
- Versatile pulling clamp - Multifunktions-Zugklemme



POWER-PULLER 4T



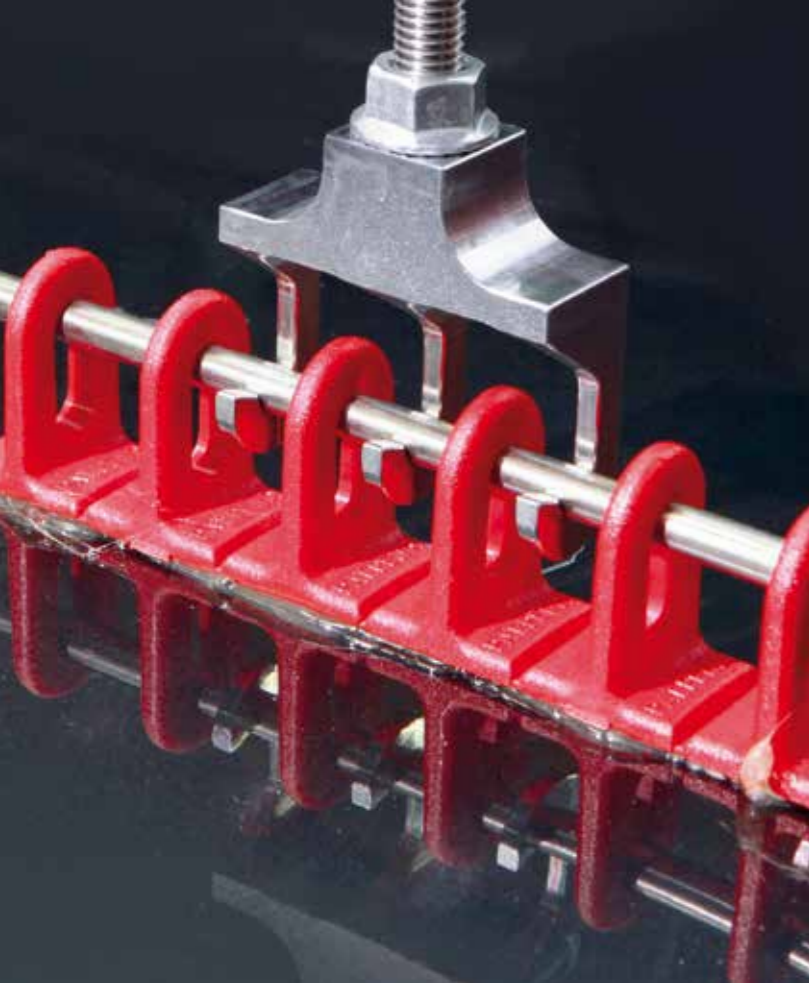

PAINTLESS DENT REPAIR

PAINTLESS DENT REPAIR MAGNETIC KIT

- Kit magnétique de débosselage sans peinture
- Magnetisches Ausbeul-Kit

053168

EXELTOOLS



PAINTLESS DENT REPAIR LAMPS

- Lampes de débosselage
- Ausbeullampe

ULTRA LIGHT CARBON X40 PW
053175

EXELTOOLS



DENT PULLING KIT (PAINTLESS)

- Kit débosselage sans peinture - Dellenausbeulhebel-Set



SET OF 6 PENCIL PUNCHES

- Kit de 6 coins de frappe - Beulenstemmer-Satz mit 6 Tefloneinsätzen



DENT PULLING INDUCTOR

- Inducteur débosselage - Dellenmatrix

GYS
DUCTION
AUTO + Dent pulling
inductor
054776

GYSDUCTION AUTO
DENT REPAIR
054981



DENT PULLING INDUCTOR

- Inspection carrosserie
- Ausbeul Induktor

Planche flexible pour inspection
de la carrosserie - Ausbeul-
Matrix
Ø 800 mm
059122

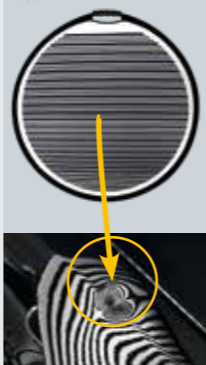

OPTION
Freezer spray
- Spray refroidisseur
-50 °C
400 ml
(x 12)
048898

AIR CUSHION KIT

- Kit coussins gonflables - Luftpolster-Spreizkissen-Satz



PNEUMATIC INERTIA HAMMER

- Marteau inertie pneumatique - Unterdruck-Schlaghammer

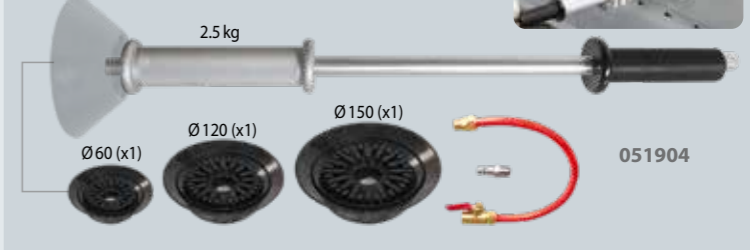

PUMP AIR SUCTION SLIDE HAMMER

- Marteau à inertie à ventouses (pompage manuel) - Man. Unterdruck-Schlaghammer



🔌	AM	⚡	Freq.	INTEGRATED TECHNOLOGY	❄️	Cable (m)	📦	⚙️
50 Hz	A	W	kHz	PFC FV	Liquid Cooling	Inductor	LxWxH cm / kg	LxWxH cm / kg
230V, 1~	16	2 400	35+120	▪▪	—	2 2.5	52 x 30 x 37 / 9.4	37 x 21 x 37 / 7.5



PDR: Paintless Dent Repair
- Débosselage rapide et sans peinture
- Lackschadenfreies Ausbeulen

PAINTLESS DENT REPAIR

BARRETTES ANNEAUX PLASTIQUE Plastic Multipads Ösen-Klebe pads

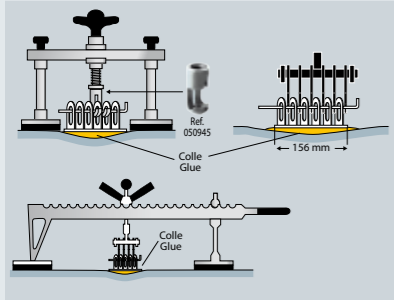
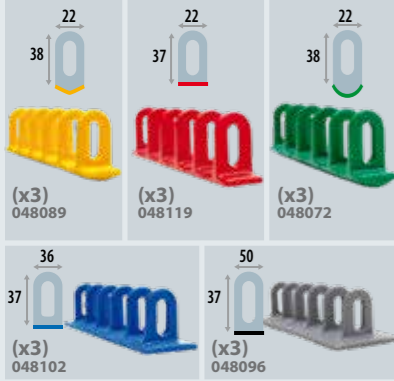

GLUE PULLING KITS

GYSMART GLUE PULLING KIT

NEW



GYSMART GLUE PULLING KIT PLUS

NEW



Workstation 054233	Set of pincil punches with 6 teflon tips 052888	Infrared thermometer 052994	Heat Gun 066311	Levelling bar 050693	6 Gripping multihook head 049734	3 Lifting rods: 150, 300 & 500 mm 050792	Set of 3 conical plastic multipads 048096 048072 048089 048119 048102	Inertia hammer 057906	Set of 6 glue tips 050952	Glue Lifter 058699	Glue Lifter 059160	33PC Paintless dent repair kit 051959	PDR Light ultra light carbon X40PW 053175	Mini puller 050921	Aluminium clamp 2 050945
--------------------	---	-----------------------------	-----------------	----------------------	----------------------------------	--	---	-----------------------	---------------------------	--------------------	--------------------	---------------------------------------	---	--------------------	--------------------------

GYSMART GLUE PULLING KIT 076051	✓														
GYSMART GLUE PULLING KIT EXPORT 076105		✓									✓				
GYSMART GLUE PULLING KIT PLUS 076082			✓												✓
GYSMART GLUE PULLING KIT PLUS EXPORT 076129				✓											✓

GLUE PULLER PRO (Steel/Alu • Acier/Alu)

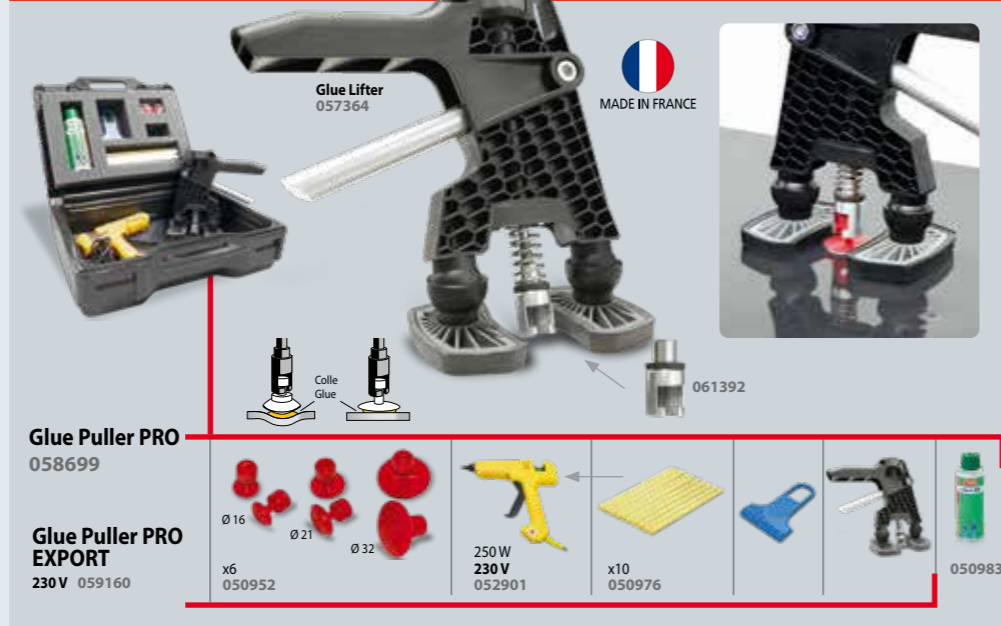

OPTIONS

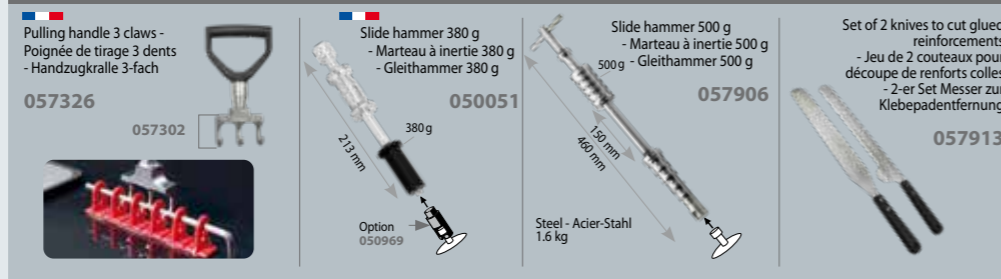

PDR TECH KIT

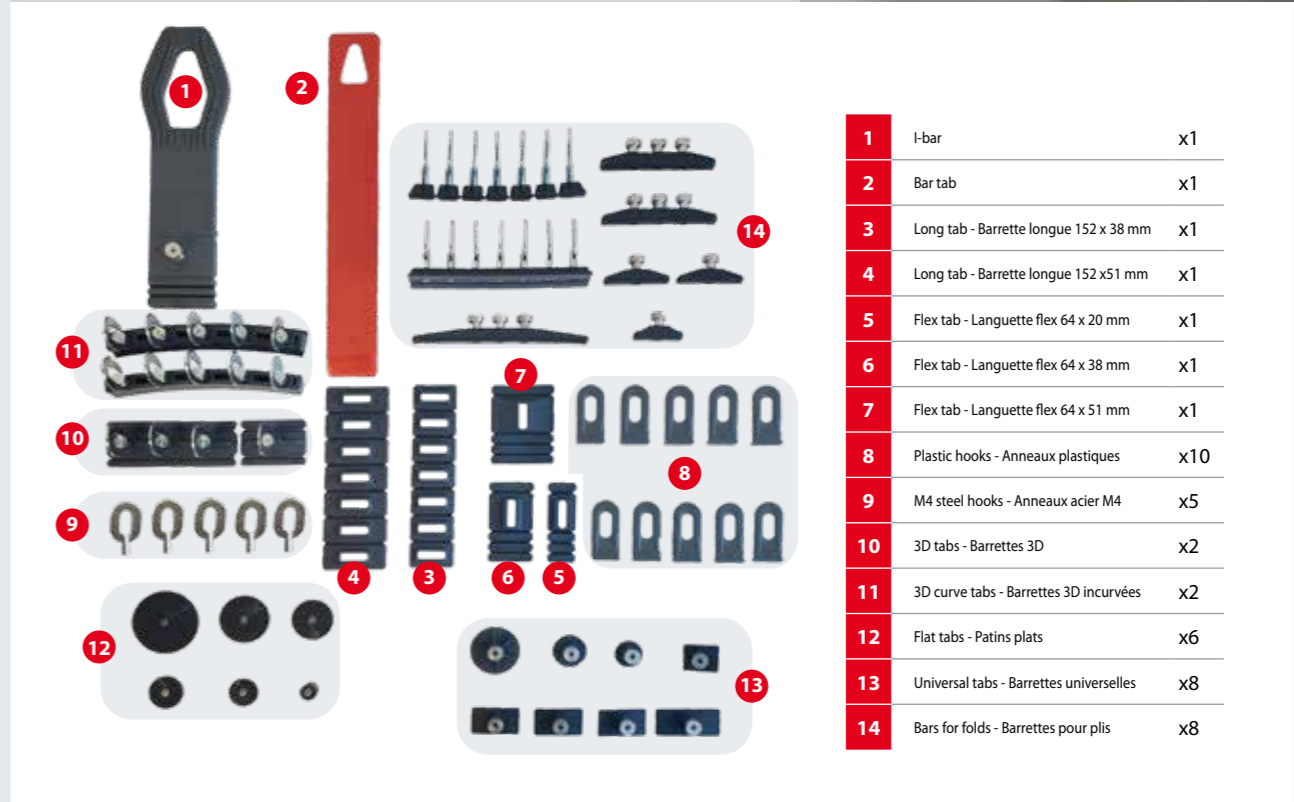

1	I-bar	x1
2	Bar tab	x1
3	Long tab - Barrette longue 152 x 38 mm	x1
4	Long tab - Barrette longue 152 x 51 mm	x1
5	Flex tab - Languette flex 64 x 20 mm	x1
6	Flex tab - Languette flex 64 x 38 mm	x1
7	Flex tab - Languette flex 64 x 51 mm	x1
8	Plastic hooks - Anneaux plastiques	x10
9	M4 steel hooks - Anneaux acier M4	x5
10	3D tabs - Barrettes 3D	x2
11	3D curve tabs - Barrettes 3D incurvées	x2
12	Flat tabs - Patins plats	x6
13	Universal tabs - Barrettes universelles	x8
14	Bars for folds - Barrettes pour plis	x8

Options

I-bar mini 080324	Bar tabs x2 080331	Long tab - Barrette longue 152 x 51 mm 080355	Long tab - Barrette longue 152 x 38 mm 080348	Flex tabs - Languettes flex 64 x 51 mm x5 080386	3D tabs - Barrettes 3D x8 080416
		M4 steel hooks - Anneaux acier M4 x5 080409	Plastic hooks - Anneaux plastiques x10 080393	Flex tabs - Languettes flex 64 x 38 mm x5 080379	
3D curve tabs - Barrettes 3D incurvées x8 080423	Universal tabs - Barrettes universelles x24 080447	Glue stick - Batons de colle x10 080454	Flat tabs - Patins plats x10 080430		



TRUCK TOOLS & MOBILE LIFTS

TRUCK TOOLS

TROLLEY IW1	51
MULTITOOL TRUCK	51

CAR LIFTS

SPOT LIFT	52
ERGO LIFT / QUICK LIFT	54
AIR JACKS	55
MANUAL WHEEL LIFT	55



TROLLEY IW1 / MULTITOOL TRUCK

TRUCK TOOLS

TROLLEY IW1
Impact wrench trolley -
Support de clé à choc

max 6.5 bar

max 20 kg

063136



Youtube

OPTIONS



Huile hydraulique
- Hydraulic oil
1l
053397

Weight, vibrations
& torque suppression -
Suppression du poids,
des vibrations et du couple

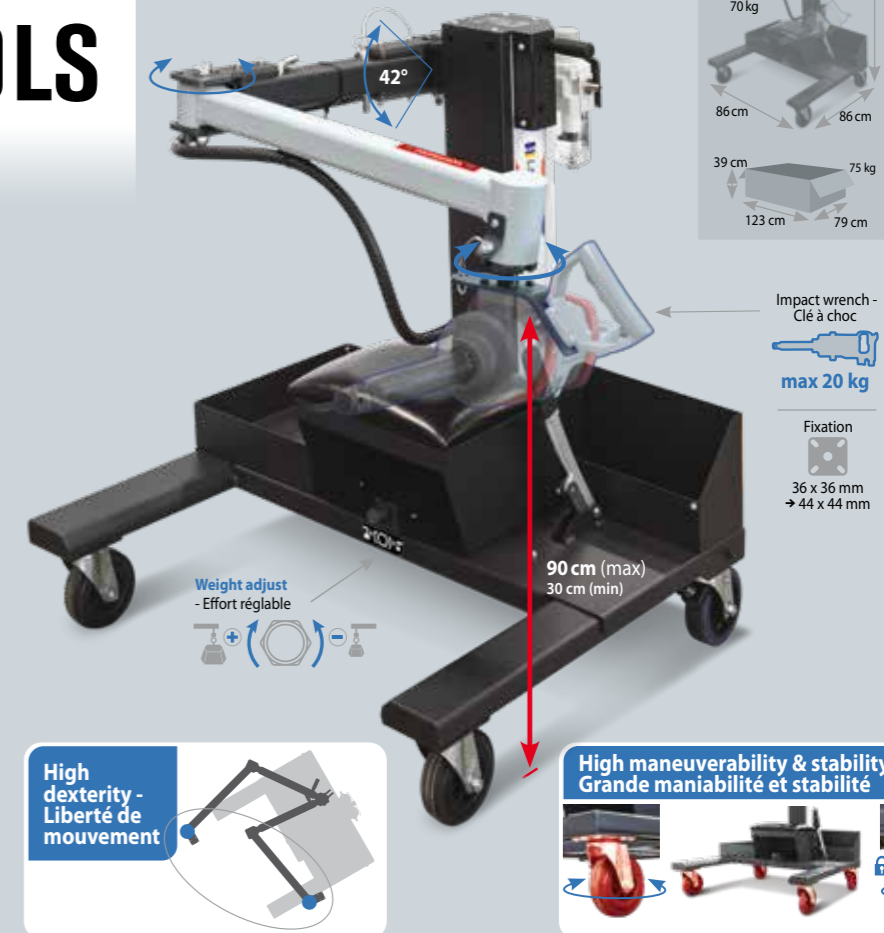

51

TRUCK TOOLS



MULTITOOL TRUCK NEW

SAFE EN 14238 + A1

max 200 kg

067158

INCLUDED



Lifting tool for brake caliper
- Outil de levage pour étrier
de frein - Hebewerkzeug für
Bremssattel

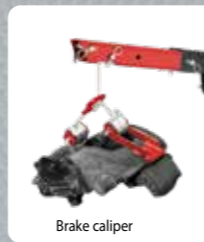

Brake caliper



Lifting tool for battery -
Outil de levage pour batterie
- Hebewerkzeug für Batterie



Truck batteries



Lifting tool for wheels -
Outil de levage pour roues
- Hebewerkzeug für Räder

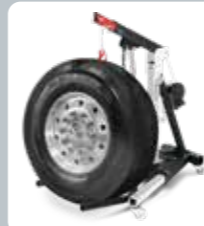

SAFE
EN 14238 + A1

ULTRA
COMPACT
103 cm

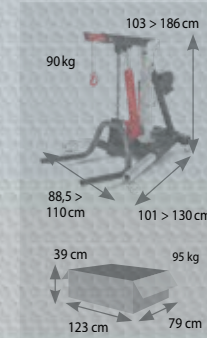

HEALTH CARE

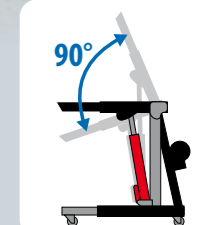
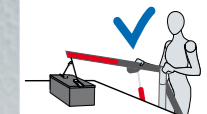



SPOT LIFT

MOBILE LIFTS

SPOT LIFT EASY

max Air 8 bar **SAFE EN 1494**
max 2.2 t

HEALTH CARE

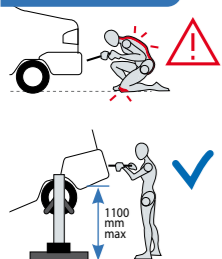

High stability - Haute stabilité

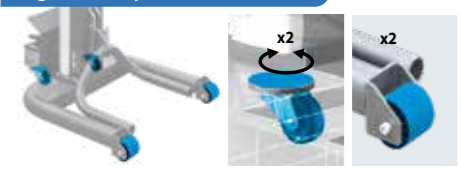

Included 220 bar 053588

SAFE EN 1494

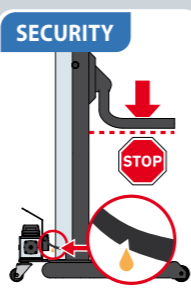

OPTIONS

Hydraulic oil 1L - Huile hydraulique 1L 053397

Rocker panel lifting tool - Outil de levage pour bas de caisse - Auflage für Seitenschweller 053236

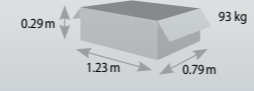

SPOT LIFT PRO

max Air 8 bar **SAFE EN 1494**
max 2.2 t

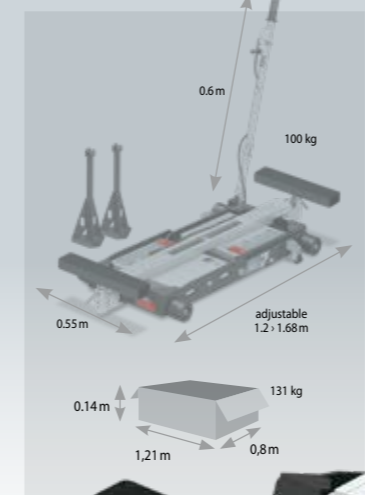

SPOT LIFT PRO MOB

max Air 8 bar **SAFE EN 1494**
max 2.2 t

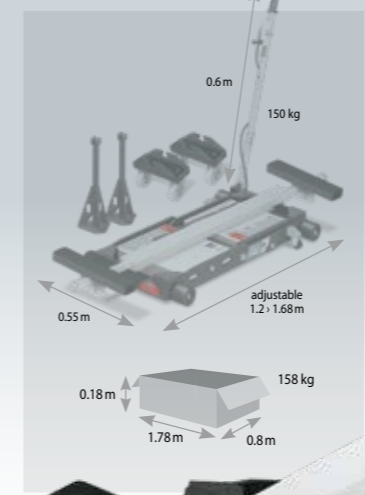

60 cm (max)
14 cm (min)

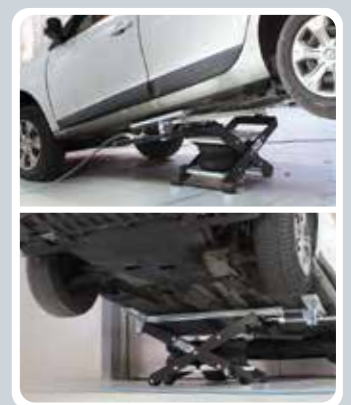

OPTIONS

Height adjuster for 4x4 & utility vehicles - Réhausseur pour 4x4 et utilitaires - Erhöhung f. 4x4 und Leicht-LKW



Pads - Patins for Audi & BMW (x 2) 053717

Ramps - Ramps 700 x 200 x 80 mm (x 2) 056787

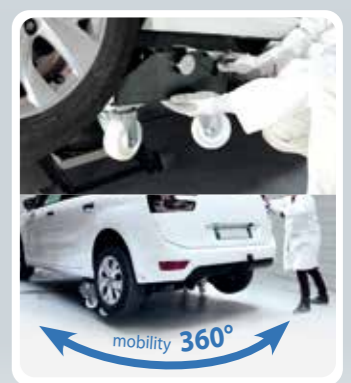

OPTIONS

SPOT LIFT PRO MOB
Réhausseur pour 4x4 et utilitaires - Height adjuster for 4x4 & utility vehicles - Erhöhung f. 4x4 und Leicht-LKW



Patins - Pads for Audi & BMW (x 2) 061606

Ramps - Ramps 700 x 200 x 80 mm (x 2) 056787

AUTO ROLL
min 500 mm
max 1700 mm (AUTOROLL 1.0m)
max 2240 mm (AUTOROLL 1.55m)
2.5 t max

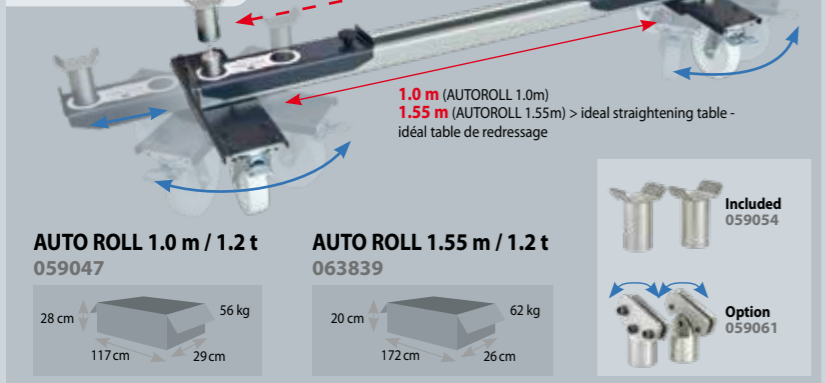

AUTO ROLL 1.0 m / 1.2 t
059047

AUTO ROLL 1.55 m / 1.2 t
063839

AFTER LIFT AUTO ROLL

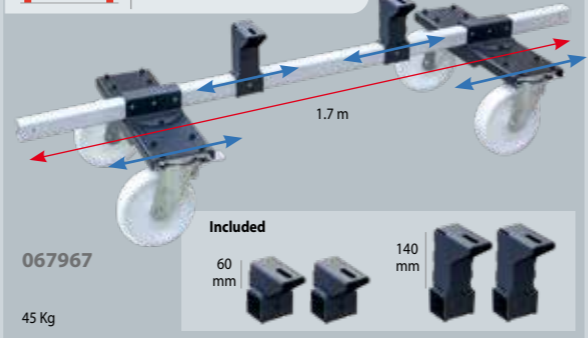
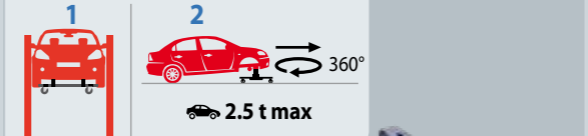

WHEEL TROLLEYS - Tabourets de manutention - Radhocker



048768
kg 650kg max

WHEEL TRUCKS - Chariots de manutention prise sous roue - Kfz-Montagelift, fahrbar

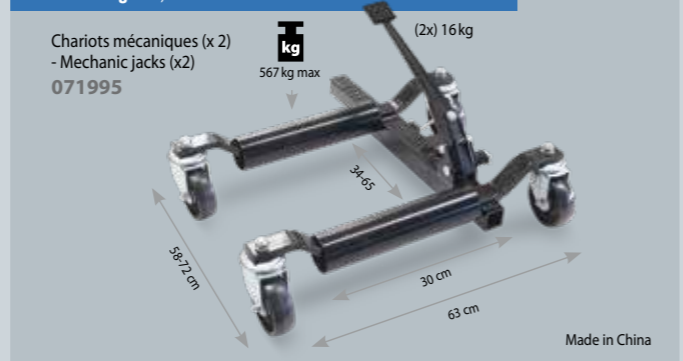

Chariots mécaniques (x 2) - Mechanic jacks (x2) 071995
567 kg max (2x) 16 kg

Made in China



ERGO LIFT 650

220 V, 1~ **SAFE EN 1493**

max 2 t

056817



Youtube

220 V, 1 ph
0.75 kW



Included
Hydraulic oil 5 L
- Huile hydraulique
5 L
062160



Adjust
± 6 cm

(x 4)

EASY 360° - Déplacements sur 360°



Removable wheels

High stability - Haute stabilité

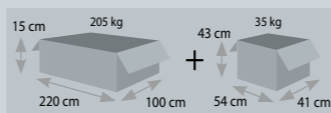

SAFE EN 1493



65 cm (max)
12 cm (min)

10 cm (min)

light weight - 200 kg

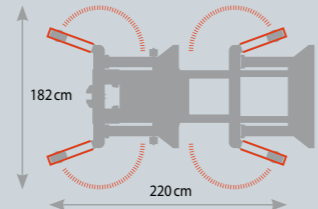
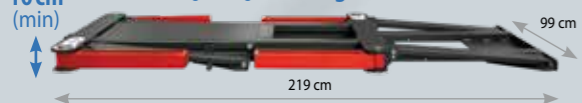

Pack ERGO LIFT 650 + 4 Wheel trolleys (x4)

068544



ERGO LIFT 1000 ROLL

Air 7-8 bars **SAFE EN 1493**

max 2.5 t

076792

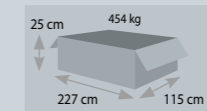

High stability - Haute stabilité



SAFE EN 1493



PATENT PENDING

Handle for adjusting the automatic locking support arms
Poignée de positionnement des bras porteurs avec verrouillage automatique

Pack ERGO LIFT 1000 ROLL + wheels



076792



ERGO LIFT 1000 ROLL 067950

Wheel kit 076776

ERGO LIFT 1000 ROLL 067950



no wheels

AIR JACKS



AIR JACK VAN 2T
058330

2T max



AIR JACK CAR 2T
058323

2T max



MANUAL WHEEL LIFT

Wheel lift trolley - Lève roue à treuil - Radmontage-Heber
061385

min: R13 / 135 / 65
max: R22 / 300 / 35
40 kg max

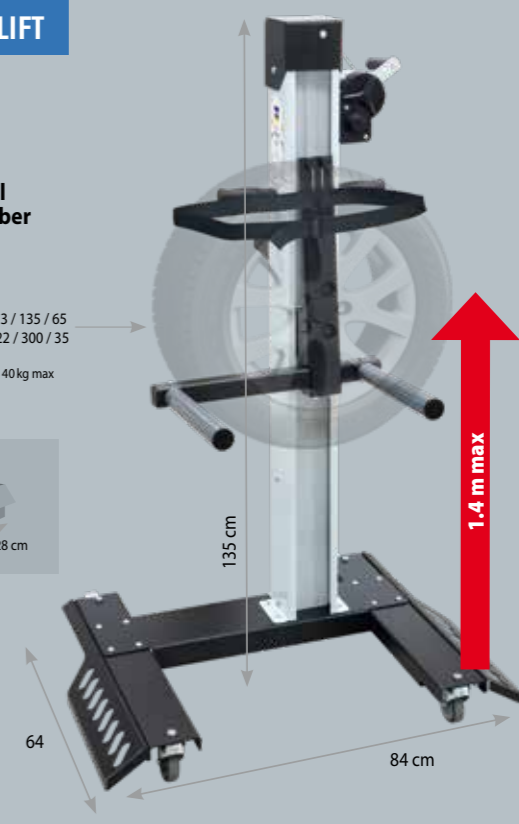
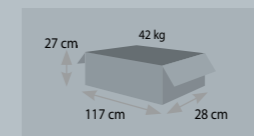

1.4 m max

QUICK LIFT L520E

062184

220 V, 1 ph
0.75 kW



Included
Hydraulic oil 5 L
- Huile hydraulique
5 L
062160



Youtube

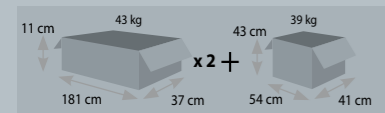

Made in China



SAFE EN 1493

2.5 t max

OPTIONS

x4 Patins à rainures
071933

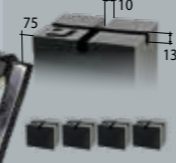

Pads for SUV - Patins pour SUV
x4
065017



Wall mount - Support mural
071926



46 cm (max)

Extensions 1680 mm x 2
066328

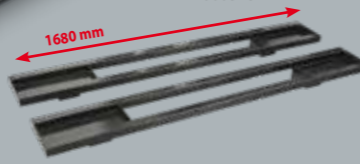



SPOT WELDING

TECHNOLOGY 58

GVSPOT 32D-X & 100R-CX 61

GVSPOT BP-LX & BP-LC-S7 62

PTI-S7 63

X & C ARMS 64

BP GENIUS 66

PTI PREMIUM PRO 68

PTI GENIUS 70

G ARMS 72

ACCESSORIES & CONSUMABLES 73

ÉVOLUTION TECHNOLOGIQUE

TECHNICAL IMPROVEMENTS - TECHNISCHE ENTWICKLUNG - MEJORAS TECNICAS

France
Facteurs d'évolution :
• Challenge CO2 = faible poids
• Crash test = ★★★★★
• Anti corrosion = nouveaux revêtements
• Esthétique et visibilité plus sophistiquées.

UK
Evolution factors :
• CO2 Challenge = low weight
• Crash test = ★★★★★
• Anti-corrosion = new coatings
• Improved aesthetics and demand for better occupant visibility.

Germany
Entwicklungsfaktoren :
• CO2 Challenge = geringes Gewicht
• Crash-Test = ★★★★★
• Anti-Korrosion = neue Beschichtung
• Modernes Technik-Design.

Italy
Fattori di evoluzione :
• Sfida CO2 = basso peso
• Crash test = ★★★★★
• Nuovi rivestimenti = anticorrosivi
• Estetica e visibilità più sofisticate

2004

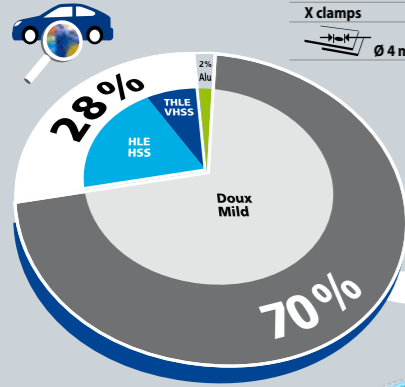

OLD SOLUTIONS

Traditional machines
180 daN max
6500 A max
X clamps
Ø 4 mm max

2023

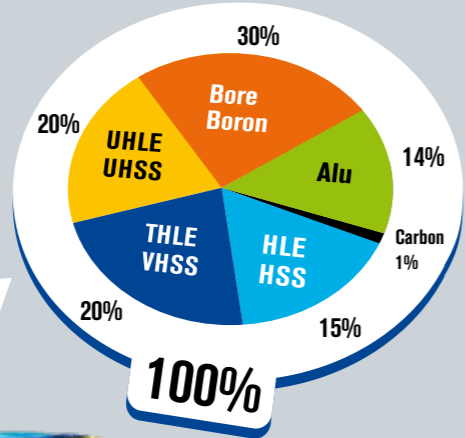

GYS SOLUTIONS

INVERTER Technology
550 daN max
14500 A max
X & C clamps
Liquid cooled system
Ø 10 mm



An example of new generation car body
• Exemple de carrosserie nouvelle génération
• Beispiel einer Karosserie der neuen Generation
• Esempio di carrozzeria di nuova generazione

- HSS - HLE
- VHSS - THLE
- UHSS - UHLE
- Bore - Boron
- Aluminium

HOMOLOGATIONS PRODUITS

MANUFACTURER APPROVALS / COMPLIANCE - PRODUKT HOMOLOGATIONEN - PRODOTTI APPROVATI



Product Category	Model	VW	Jeep	Mercedes	Smart	EvoBus	Nissan	GM	Tata	Other
DENT PULLER	GYSPT 2600/2700	•	•	•	•	•	•	•	•	•
	GYSPT 36-39.02/04, PRO230/400, EXPERT 200/230/400	•	•	•	•	•	•	•	•	•
	Workstations	•	•	•	•	•	•	•	•	•
	GYSPT ALU FV	•	•	•	•	•	•	•	•	•
RESISTANCE SPOT WELDER	GYSPT ARCPULL 200	•	•	•	•	•	•	•	•	•
	GYSPT 100R	•	•	•	•	•	•	•	•	•
	GYSPT BP-LX	•	•	•	•	•	•	•	•	•
	GYSPT BP-LC-s7	•	•	•	•	•	•	•	•	•
	GYSPT BP GENIUS	•	•	•	•	•	•	•	•	•
	GYSPT PTI-s7	•	•	•	•	•	•	•	•	•
	GYSPT PTI PREMIUM PRO	•	•	•	•	•	•	•	•	•
	GYSPT PTI GENIUS	•	•	•	•	•	•	•	•	•
SPOT WELDER	•	•	•	•	•	•	•	•	•	
RIVE / MIG	GYSPPRESS	•	•	•	•	•	•	•	•	•
	CARMIG	•	•	•	•	•	•	•	•	•
MIG / MAG	E1 GYS AUTO	•	•	•	•	•	•	•	•	•
	E2 E3 GYS AUTO	•	•	•	•	•	•	•	•	•
	AUTOPULSE 220-M1	•	•	•	•	•	•	•	•	•
	AUTOPULSE 220-M3	•	•	•	•	•	•	•	•	•
	AUTOPULSE 320-T1	•	•	•	•	•	•	•	•	•
PLASMA	VAS 821 005 - Pulse MIG	•	•	•	•	•	•	•	•	•
	VAS 821 00580 023	•	•	•	•	•	•	•	•	•
PLASMA	EASYSCT 40	•	•	•	•	•	•	•	•	•
	CUTTER 25K/35KF	•	•	•	•	•	•	•	•	•
	CUTTER 30FV/45CT	•	•	•	•	•	•	•	•	•
GYSDUCTION AUTO	•	•	•	•	•	•	•	•	•	•

RANGE

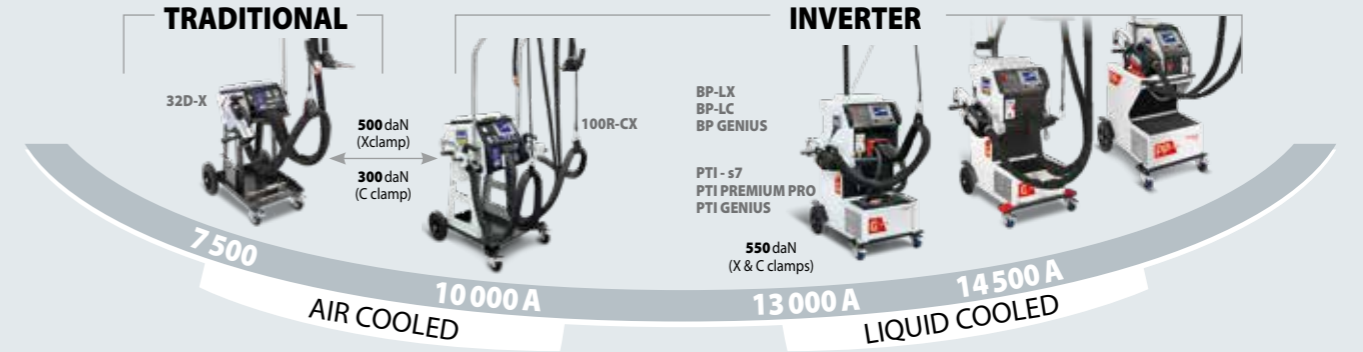

Model	32 D	100 R	BP / BP GENIUS	PTI-s7	PTI PREMIUM PRO	PTI GENIUS
-------	------	-------	----------------	--------	-----------------	------------

Mild - Doux	•	•	•	•	•	•
HSS/VHSS - HLE/THLE → ⚠	X	•	•	•	•	•
UHSS/BORON - UHLE/BORE	X	Difficult	•	•	•	•

Number of spots - Nombre de points 10 spots/min	0.8 + 0.8 mm	100	150	no limit	no limit
	2.5 + 2.5 mm	5	10	95	60

Inverter Technology	—	•	•	•	•
EMF Directive 2013/35/UE (⚡)	—	—	BODY PROTECT TECHNOLOGY	•	•
Cooling system - Système de refroidissement	AIR ❄️	AIR ❄️	LIQUID ❄️	LIQUID ❄️	LIQUID ❄️
Automated regulation - Régulation automatique	I (A)	—	•	•	•
	daN	—	•	•	•
	Ø	irregular	constant	constant	constant

MODE AUTO	—	—	• (LC, LG)	•	
Pince - Clamp	X	• (32DX)	• (BP.LX)	—	
	C	—	• (BP.LC, BP.LG)	• G clamp	
	X+C	—	• (100R-CX)	—	
Transformer Inside Clamp	—	—	—	•	
Cables (L)	2.5 m	2.5 m	2.5 m	4 or 6 m	6 m
Includes gun	•	•	•	option	option

Max welding frequency (spots/min) - Cadence de soudage maximale (points/min)	0.8 + 0.8 mm	10	10	BP-LC : 10 - BP-LG : 20	10	20				
	2.5 + 2.5 mm	6	2	6	10	2	6	10	10	20
Fuse	400 V	32 A	32 A	40 A	50 A	32 A	40 A	50 A	20 A	25 A
	200/208-240 V	—	—	—	—	60 A	80 A	100 A	40 A	50 A



SPOT WELDING

PORTASPOT 230

6 300 A 120 daN

Air cooled

230V
022256



DELIVERED WITH PX 1



ARMS Ø 23 mm

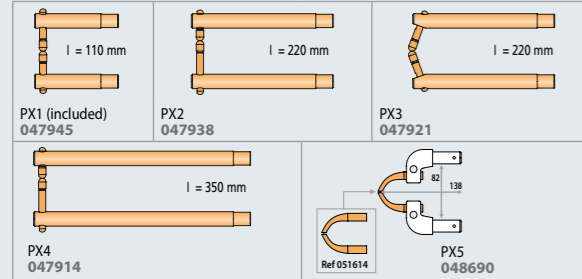

ELECTRODES

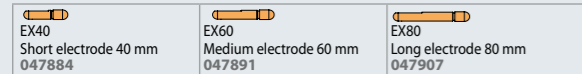

CAPS & ACCESSORIES



50/60 Hz	A	A	A	mm	V	m	mm ²	100% CU	LxWxH cm / kg
1 x 230V	16(D)	6 300	8 900	2+2	2.45	2.5	3x2.5 H05VVf	OK	41 x 18 x 22 / 11.3

GYSPOT 32D-X

7 500 A 500 daN

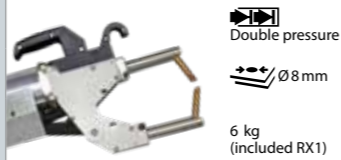

Air cooled

2 x 400V
019881



included	
Monopoint/Spot 049291	▪
Inertia hammer 049482 + 049802	▪
Spotter box pro 050075	▪
Top support box	▪
Contact grease 050440	▪
Caps remover 050846	▪
Cable support	▪
RX1 051034	▪
RX2 051041	▪

GYSPOT 100R-CX

10 000 A 500 daN (X) 300 daN (C)

For mild steel, HSS, UHSS

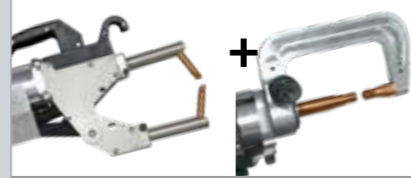

Air cooled

Traceability software
Save spot welding configuration and export data

3 x 400V
022317

included	
Monopoint/Spot 049291	▪
Inertia hammer 049482 + 049802	▪
Spotter box pro 050075	▪
Top support box	▪
Contact grease 050440	▪
Caps remover 050846	▪
Cable support	× 2
RX1 051034	▪
RC1 051065	▪
RC3 051089	▪



OPTION 100R-CX

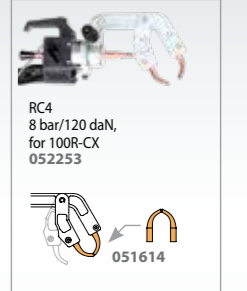

OPTIONS



MADE IN FRANCE CE NORM. 62135	50/60 Hz	A	Spots/min (max)	RMS	MAX	mm	Uo	Cables			100% CU	LxWxH cm / kg
								Air Cooled	m	mm ²		
GYSPOT 32D.X	400V	32 (13 kVA)	6	7 500	10 500	3 + 3	1,2 + 3	2,2	200	OK	79 x 57 x 54 / 111	
								2,5	150			
								8	3 x 6 HO7RNF			
GYSPOT 100R.CX	3 x 400V	40 (28 kVA) 50 (35 kVA)	2 6 10	10 000	—	2.5+2.5+2.5	1,5 + 3	2,5	200	OK	61 x 79 x 71 / 137	
								2,5	150			
								8	4 x 6 HO7RNF			

GYSPOT BP-LX
13 000 A
550 daN

For mild steel, HSS, UHSS **Boron steel**

Double pressure
Ø 10 mm
6.5 kg (included X1)

Liquid cooled

BP BODYPROTECT
Unique electro-magnetic field protection
2013/35/UE by GYS

Traceability software
Save spot welding configuration and export data

019652

	019652	058804
400V		
Gyspot BP-LX	▪	▪
Monopoint/Spot 049291	▪	▪
Spotter box pro (p.10) 050075	▪	▪
Inertia hammer 049482 + 049802	▪	▪
X1 050501	▪	▪
X4A (x2) + X4B + X4C + X2 020733	▪	▪
Liquid cooling (10L) 052246		(x3)

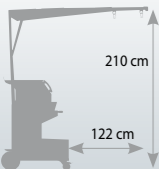

OPTIONS

050068
x10 (x20: 052239)
x6 (x6: 049994)

x18 (x6: 049987)
x18 (x6: 049970)

Caps type A box 048935
Caps type F box 077119

x40 (x6: 049987)
x40 (x6: 049970)

SD CARD 050914

Cooling liquid
- Liquide de refroidissement
- Kühlmittel
- Enfríamiento líquido
- Refrigeração líquida
10L

Protection cover
- Housse de protection
- Schutzhäube
for BP & PTI
050853

GYSPOT BP-LC-s7
13 000 A
550 daN

For mild steel, HSS, UHSS **Boron steel**

Double pressure
Ø 10 mm
6.5 kg (included C1)

Liquid cooled

BP BODYPROTECT
Unique electro-magnetic field protection by GYS

Traceability software
Save spot welding configuration and export data

020757

	020757	058798
400V		
Gyspot BP-LC-s7	▪	▪
Monopoint/Spot 049291	▪	▪
Spotter box pro (p.10) 050075	▪	▪
Inertia hammer 049482 + 049802	▪	▪
Contact grease 050440	▪	▪
Caps remover 050846	▪	▪
Arm panel	▪	▪
C1 019140	▪	▪
C2 + C3 + C4 060821	▪	▪
C6 022409	▪	▪
Liquid cooling (10L) 052246		(x3)



OPTIONS BP-LC

S1 < nov 2010 048171

S2 > nov 2010 048188

GYRO 360° for BP-LC 051737

10-14 kg

Mandrels for gun - Mandrins pour pistolets - Pistole & Anschlußstücke, Zubehör

GYSPOT PTI-s7
14 500 A
550 daN

For mild steel, HSS, UHSS **Boron steel**

FUSE 20 A
Double pressure
Ø 10 mm
9.9 kg (included C1)

TRANSFORMER INSIDE

Liquid cooled

Traceability software
Save spot welding configuration and export data

020894

	4M 020894	4M 067998
220V	6M 022195	6M 020900
Gyspot PTI-s7	▪	▪
Contact grease 050440	▪	▪
Caps remover 050846	▪	▪
Arm panel	▪	▪
C1 021402	▪	▪
C2 + C3 + C4 060821	▪	▪
C6 022409	▪	▪
Gyro 360° 051720	▪	▪
Complete gun kit 067318	▪	▪
Liquid cooling (10L) 052246		(x3)

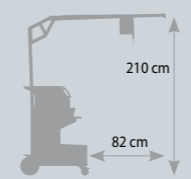

Very light
9.9 kg

CONVERT PTI S-7 > PTI PREMIUM PRO WITH G ARMS

KIT RENOV PTI PREMIUM PRO 220V 072367

400V 072541

C ARMS **G ARMS**

OPTION

200 mm² 1.6 m
300 mm² 1m

Complete gun kit 067318

GYRO 360° for PTI 051720

High stability Compatible gyro

MADE IN FRANCE 62135	50/60 Hz	A D curve	Spots/min (max) ± 2.5+2.5	RMS A	Uo V	mm			Cables			100 % CU	cm	kg
						↕	↔	↔	↔	↔	↔			
GYSPOT BPLX	3 x 400V	32 (22 kVA) 40 (28 kVA) 50 (35 kVA)	2 6 10	13 000	16	2.5+2.5+2.5	1.5 + 3	2.5, liquid	2.5	8 m, 4x6 HD7RNF	OK	65 x 80 x 205	164.5	
GYSPOT BPLC-s7														
GYSPOT PTI-s7	3 x 400V	20 (14 kVA)	10	14 500	7.3	2.5+2.5+2.5	1.5 + 3	4 m, liquid 6 m, liquid	OPTION 067318 : 1.6 m, Ø 200 mm ²	8 m, 4x4 HD7RNF	OK	65 x 80 x 230	105.3	
GYSPOT PTI-s7 220 V														
	3 x	200 208 220 240		12 500 13 000 14 500 14 500	6.5 6.7 7.4 7.7			4 m, liquid 6 m, liquid		8 m, 4xAWG8 (SOOW)	OK		115.7	

FOR GYSPOT 32D-X, 100R-CX, BP-LX

550 daN

6,5 kg including X1

- DOUBLE PRESSURE
- LIQUID COOLED / REFRIGERATION LIQUIDE
- Ø 10 mm



MADE IN FRANCE

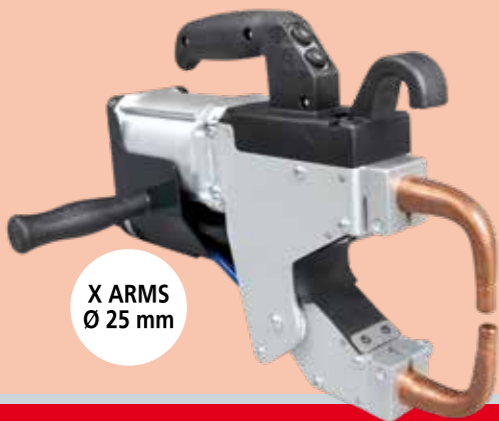

X ARMS Ø 25 mm

X Arms - Caps Ø13 mm

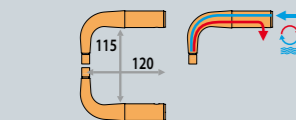

X1 8 bar/550 daN

050501

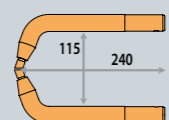

X2 8 bar/400 daN

050518

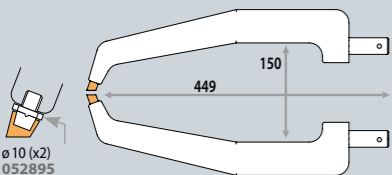

X4 8 bar/120 daN

050532

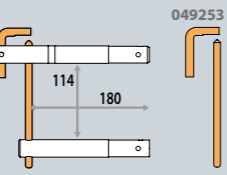

X5 8 bar/200 daN

050549

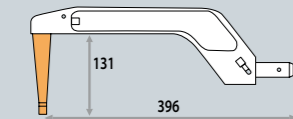

X4A 8 bar/150 daN

020702

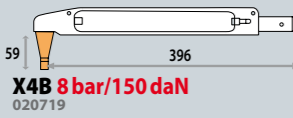

X4B 8 bar/150 daN

020719

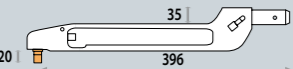

X4C 8 bar/150 daN

020726

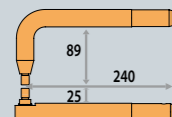

X6 8 bar/400 daN

050587

X4 (A, B & C) combinations



X4A + X4A



X4A + X4B

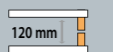

X4B + X4B



X4A + X4C



X4C + X4C

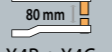

X4B + X4C

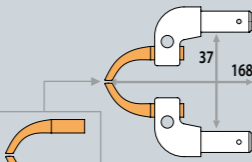

X11 3 bar/150 daN

051607

X ARMS PANELS

X4A (x2) + X5 + X2

022324

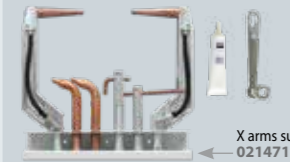

X arms support 021471

X4A (x2) + X4B + X4C + X2

020733

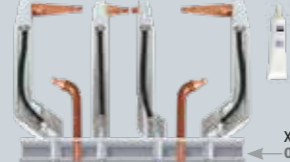

X arms support 021471

Remote control (BP)



Digital screen control Change Mode & Parameters

X clamp control



C clamp control

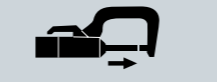

C ARMS PANELS



- C2
- + C3
- + C4

ALL IN 1 BOX



- C2 +
- C3 +
- C6 +
- C12 +
- C9

061316

2 BOXES



- C10 +
- C3 +
- C5 +
- C6 +
- C9

076495

NEW



FOR GYSPOT BP-LG, PTI

550 daN

6,5 kg including C1

- DOUBLE PRESSURE
- LIQUID COOLED / REFRIGERATION LIQUIDE
- Ø 10 mm



MADE IN FRANCE

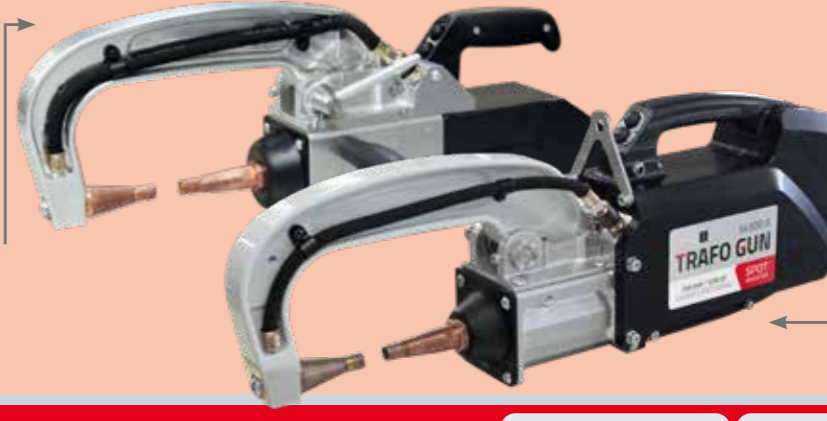

550 daN

Transformer inside

9,9 kg including C1

- DOUBLE PRESSURE
- AIR COOLED + LIQUID COOLED / DOUBLE REFRIGERATION AIR + LIQUID
- Ø 10 mm

C Arms - Caps Ø13 mm

Classic arms



CLASSIC FINISH

Bras isolés - Isolated arms - Isolierte Bügel

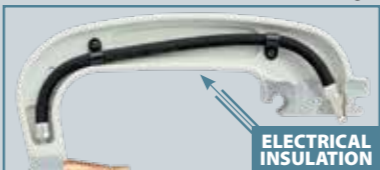

ELECTRICAL INSULATION

PTI arm support kit 077577

BP arm support kit 080089

Arm lock pin 062405

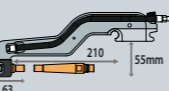

C2 8 bar/550 daN

022386

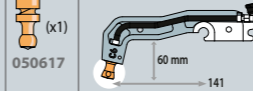

C6 8 bar/300 daN

022409

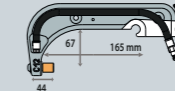

C12 8 bar/550 daN

022997

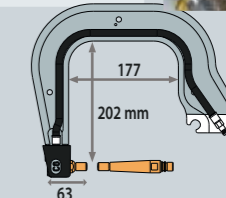

C8 8 bar/550 daN

021440

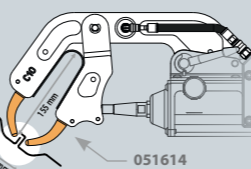

C10 4 bar/150 daN

051638

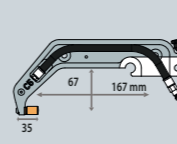

C5 8 bar/550 daN

022393

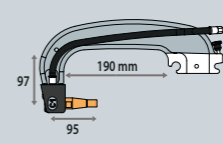

C1 8 bar/550 daN

021402

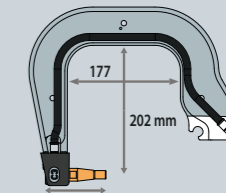

C3 8 bar/550 daN

021419

X Arms - Caps Ø13 mm

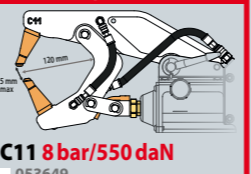

C11 8 bar/550 daN

053649

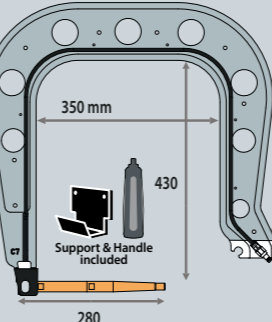

C7 8 bar/550 daN

021433

Option for C7

C7-SA (Small Access) 067684

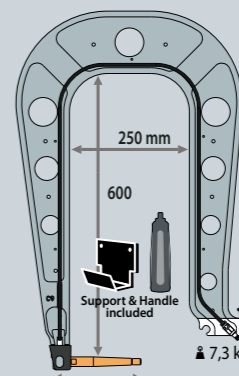

C9 8 bar/550 daN

020078

Option for C9 & C14

C9/C14-SA (Small Access) 067660

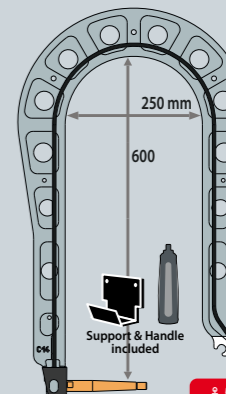

C14 8 bar/400 daN

023543

▲ 5,7 kg 22% saved



GYSPOT

SPOT WELDING BP

G
ARMS

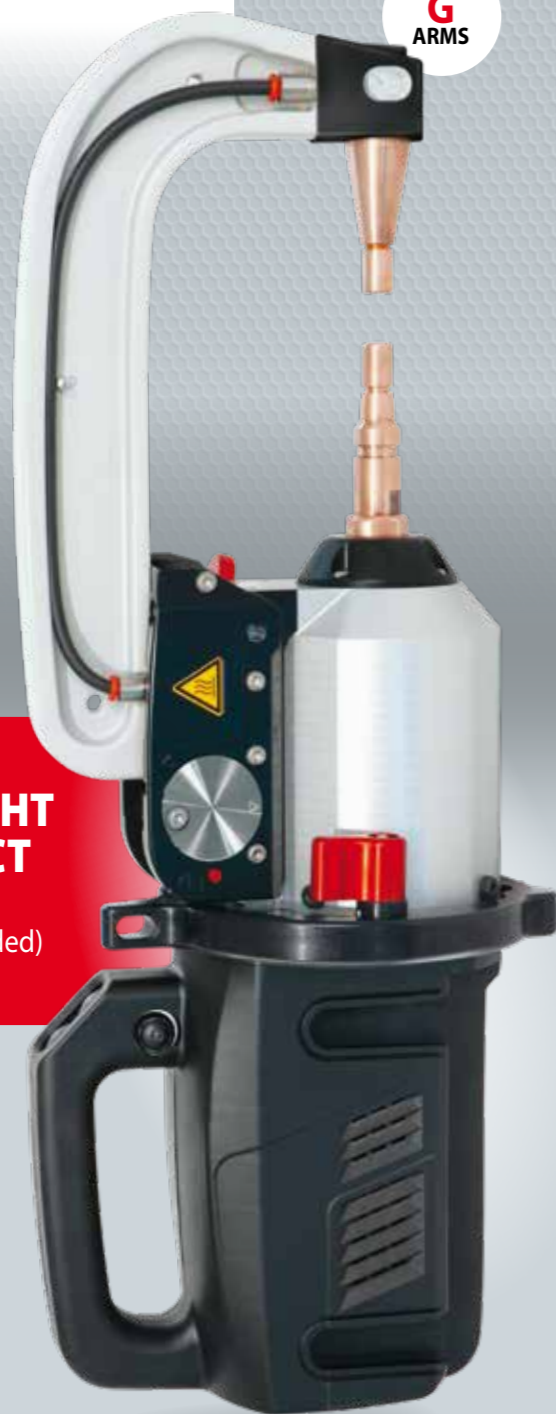

ULTRA LIGHT & COMPACT
6.5 kg
(Gyro & G1 included)



MADE IN FRANCE

550 daN

LIQUID COOLED
REFROIDISSEMENT
LIQUIDE

Ø 10 mm

6.5 kg

(Gyro & G1 included)



Youtube

OPTIONS



Caps type A box
048935
x40 (x6: 049987)
Caps type B box
077119
x40 (x6: 049970)

x20 (x6: 049987)
x6 (x6: 049970)
x2 (x1: 050617)
073449



Cooling liquid
- Liquide de refroidissement
- Kühlmittel
- Enfriamiento líquido
- Refrigeração líquida
052246



Protection cover
- Housse de protection
- Schutzhaube
for BP & PTI
050853



10-14 kg
059696

FAST OPEN XL

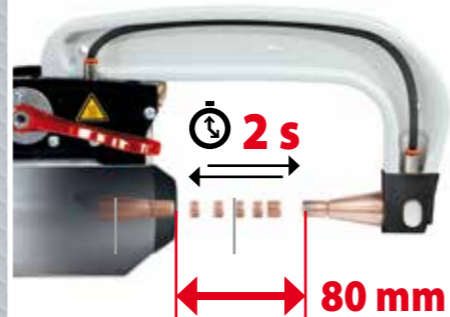

EASY



GYRO INTEGRATED



PERFECT ELECTRICAL CONNECTION



AUTO



GYSPOT BP GENIUS

13 000 A
550 daN

For mild steel, HSS, UHSS Boron steel

BP BODYPROTECT
2013/ISS/UE Unique electro-magnetic field protection by GYS

Traceability software
Save spot welding configuration and export data



023451



	023550	023451	023499
Gyspot BP GENIUS	220V	400V	
Monopoint/Spot 049291	▪	▪	▪
Spotter box pro (p.10) 050075	▪	▪	▪
Inertia hammer 049482 + 049802	▪	▪	▪
Caps remover 050846	▪	▪	▪
Arm support	▪	▪	▪
G1 022768	▪	▪	▪
G2 + G3 + G4 022896	▪	▪	▪
Liquid cooling (10L) 052246			(x3)

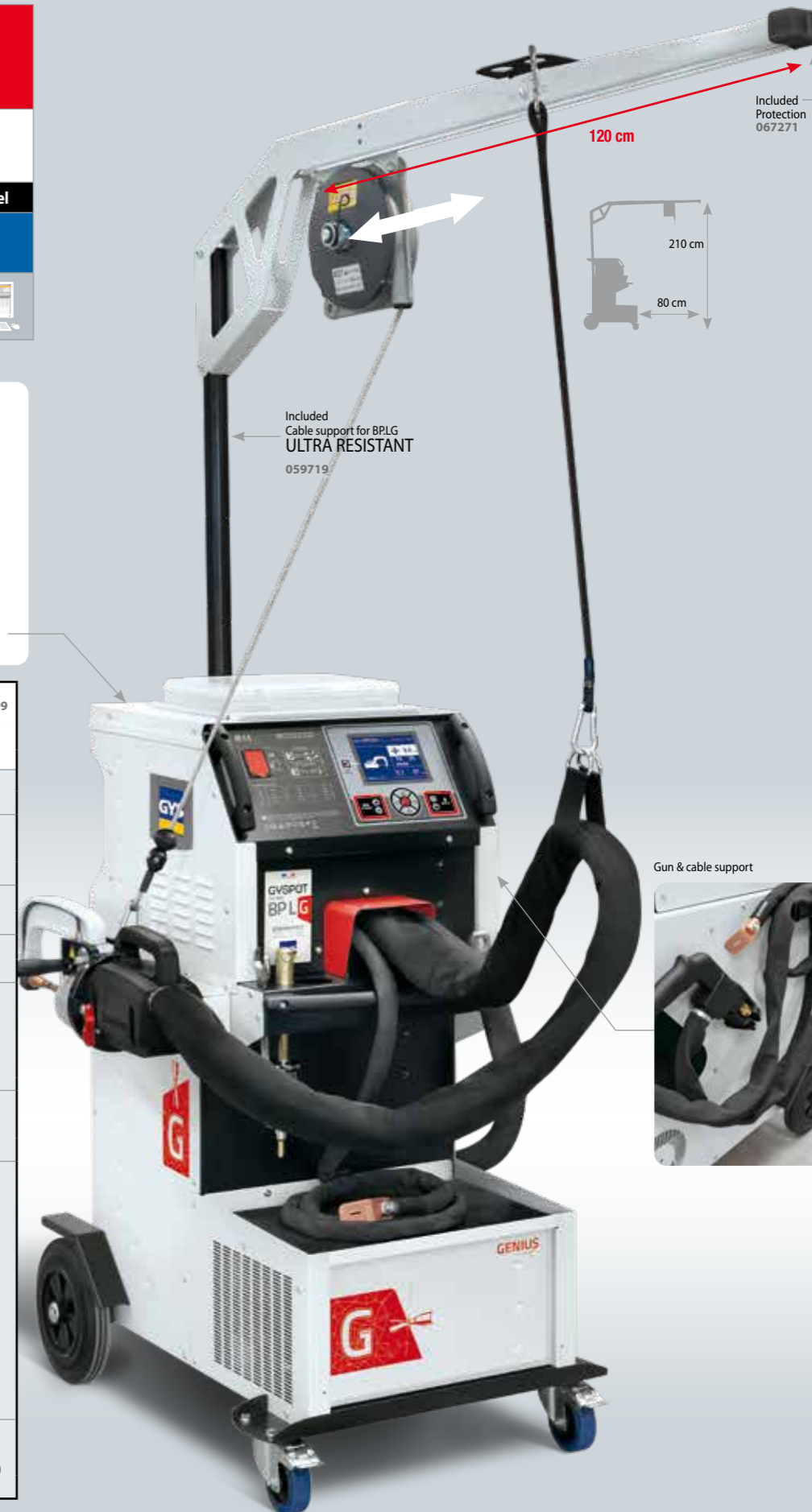

67

GYSPOT BP GENIUS

LIQUID COOLED

MADE IN FRANCE 62135	50/60 Hz	A D curve	Spots/min (max) 2.5+2.5	I _{RMS} A	U _o V	mm			Cables			100% CU	cm	kg
						2.5	1.5	3	2.5 m, Ø 200 mm ² , Liquid	2.5 m, Ø 150 mm ² air	8 m 4x16 mm ² (6AWG) 500W			
GYSPOT BP GENIUS 220 V	3 x	200 208 220 240	2 6 10	10 500 11 000 12 000 12 500	15 15.5 17 18	2.5+2.5+2.5	1.5+3	2.5 m, Ø 200 mm ² , Liquid	2.5 m, Ø 150 mm ² air	8 m 4x16 mm ² (6AWG) 500W	OK	65 x 80 x 205	178	
GYSPOT BP GENIUS 400V	3 x 400V	32 (22 kVA) 40 (28 kVA) 50 (35 kVA)	2 6 10	13 000	16	2.5+2.5+2.5	1.5+3	2.5 m, Ø 200 mm ² , Liquid	2.5 m, Ø 150 mm ² air	8 m 4x6 mm ² H07RNF	OK	65 x 80 x 205	171	



GYS POT

SPOT WELDING PREMIUM PRO

G
ARMS



**FULL
ERGONOMIC**

10.3 kg
(Gyro & G1 included)

550 daN

LIQUID COOLED
REFROIDISSEMENT
LIQUIDE
Ø 10 mm

10.3 kg
(Gyro & G1
included)

Ergonomy & Security

20°
**EASY
HANDLE**

**LOCKING
SYSTEM**



TRANSFORMER INSIDE

GYRO INCLUDED



PERFECT ELECTRICAL CONNECTION

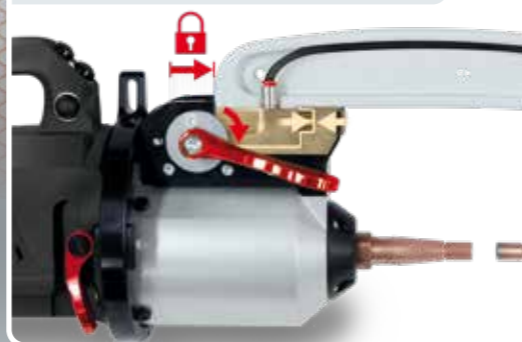

AUTO



XL Balancer

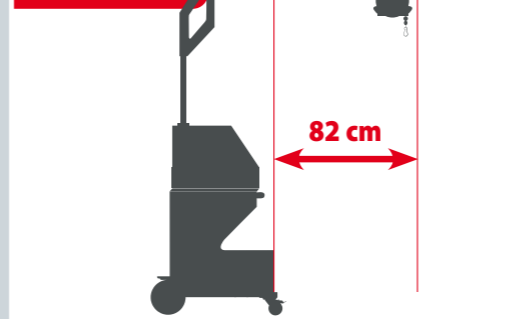

OPTIONS

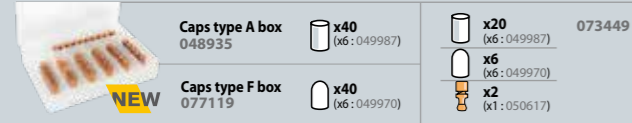

**GYS POT
PTI PREMIUM PRO**

**14500 A
550 daN**

For mild steel, HSS, UHSS



TRANSFORMER INSIDE

Liquid cooled

Traceability software
Save spot welding configuration
and export data

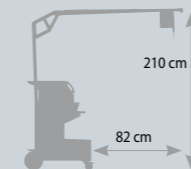

NEW



	6M		
	072206	072183	
	220 V	400 V	
GYS POT INVERTER PTI PREMIUM PRO			
Caps remover 050846			
Arm panel			
G1 022768			



OPTIONS

**G11
for PTI PREMIUM
PRO only**

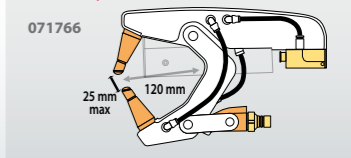

MADE IN FRANCE	50/60 Hz	A D curve	Spots/min (max)	RMS A	Uo V	mm	Cables			100 % CU	cm	kg
							6 m, liquid	8 m, 4x4 H07RNF	8 m, 4x4 H07RNF			
GYS POT PTI PREMIUM PRO 220V	3 x	30 (10-12 kVA) 40 (14-16 kVA) 50 (17-21 kVA)	10	12500 13000 14500 14500	6.6 6.9 7.3 7.9	2.5+2.5+2.5 1.5+3	6 m, liquid	OPTION 067226; 1.8 m, Ø 300 mm²	8 m, 4x4 H07RNF	OK	65 x 100 x 230	118.7
GYS POT PTI PREMIUM PRO 400V	3 x 400V	25 (14 kVA)	10	14 500	7.3	2.5+2.5+2.5 1.5+3	6 m, liquid	OPTION 067226; 1.8 m, Ø 300 mm²	8 m, 4x4 H07RNF	OK	65 x 100 x 230	109.2



GYSPOT

SPOT WELDING GENIUS



MADE IN FRANCE

550 daN

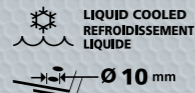

11.3 kg
(Gyro & G1 included)

FAST OPEN XL

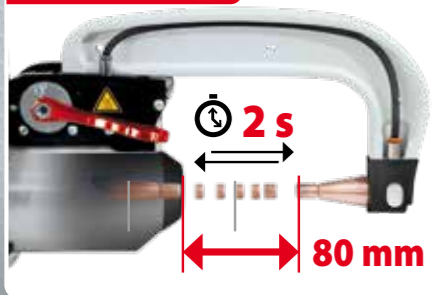

GYRO INTEGRATED

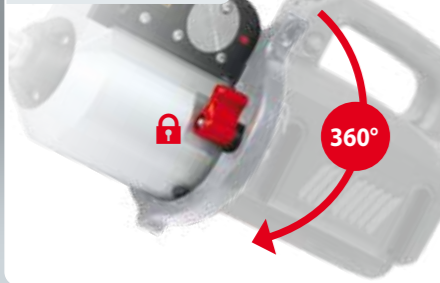

PERFECT ELECTRICAL CONNECTION

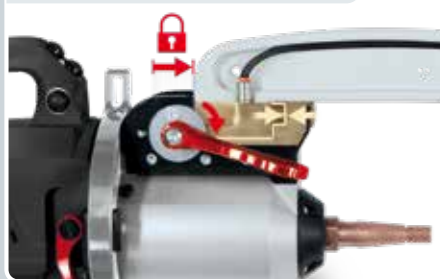

AUTO

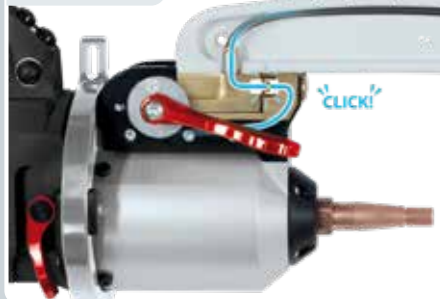

TRANSFORMER INSIDE



G
ARMS



Motorised cable support
- Potence électrique
- Elektrisch verstellbarer
Kabelsupport

Control command
- Contrôle de commande

OPTIONS

	Caps type A box 048935 (x6: 049987)		SD CARD 050914		Kit WIFI Compatibility : Gyspot Inverter PTI-GENIUS 070691		Cooling liquid - Liquide de refroidissement - Kühlmittel - Enfriamiento líquido - Refrigeração líquida 052246		Protection cover - Housse de protection - Schutzhaube for BP & PTI 050853	
	Caps type F box 077119 (x6: 049970)		x20 (x6: 049987)		x6 (x6: 049970)		x2 (x1: 050617)		10L for PTI GENIUS 077126	

GYSPOT PTI GENIUS

14 500 A
550 daN

For mild steel, HSS, UHSS Boron steel

TRANSFORMER INSIDE

Liquid cooled

Traceability software
Save spot welding configuration and
export data

	024854	024878	068001	024892
	220V	400V	480V	
Gyspot PTI-GENIUS				
Caps remover 050846				
Arm support				
G1 022768				
G2 + G3 + G4 022898				
Kit gun 067226				
Liquid cooling (10L) 052246			(x3)	

Ergonomic

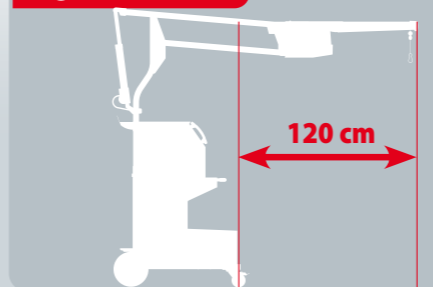

Included
Cable support
ULTRA
RESISTANT



ELECTRIC
MOTOR

Control
Commande

Electrode storage
- Rangement pour
électrodes

6 m

High stability -
Grande stabilité

OPTIONS

Kit gun
067226

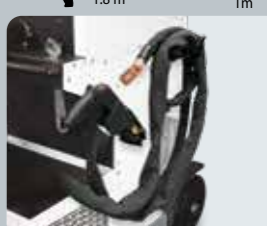

MADE IN FRANCE 62135	50/60 Hz	A D curve	Spots/min (max) 2.5+2.5	RMS A	Uo V	mm		Cables		cm	kg
						mm	mm	mm	mm		
GYSPOT PTI GENIUS 220 V	3 x	200	50 (17-21 kVA)	20	12 500	2.5+2.5+2.5	1,5+3	6 m, Liquid	8 m 4xAWG8 (500W)	71 x 90 x 200	136.2
		208			13 000						
		220			14 500						
GYSPOT PTI GENIUS 400V	3 x 400 V	25 (17 kVA)	20	14 500	7	2.5+2.5+2.5	1,5+3	6 m, Liquid	8 m 4x4 mm ² H07RN6	71 x 90 x 200	185.5
		240			7.9						
GYSPOT PTI GENIUS 480V	3 x 480 V	20 (17 kVA)	20	14 500	7	2.5+2.5+2.5	1,5+3	6 m, Liquid	8 m 4xAWG12 (500W)	71 x 90 x 200	128.7

FOR GYSPOT BP GENIUS, PTI PREMIUM PRO & PTI GENIUS

G Arms - Caps Ø13 mm

Bras isolés - Isolated arms - Isolierte Bügel

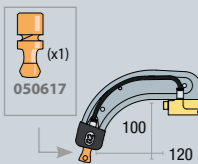

G2
8 bar/300 daN
022775

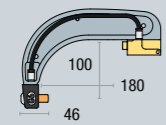

G6
8 bar/550 daN
022812

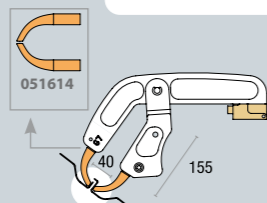

G7
4 bar/150 daN
022829

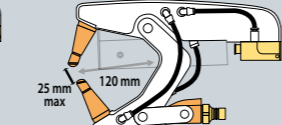

G11
8 bar/550 daN
for PTI PREMIUM PRO only
071766

Kit de maintenance connecteurs pince G - Connectors maintenance kit for G clamp 067295

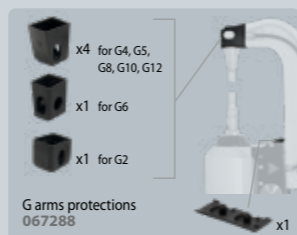

G arms protections
067288

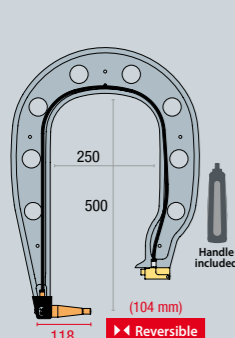

G4
8 bar/550 daN
022799

Option for G4

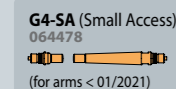

G4-SA (Small Access)
064478
(for arms < 01/2021)

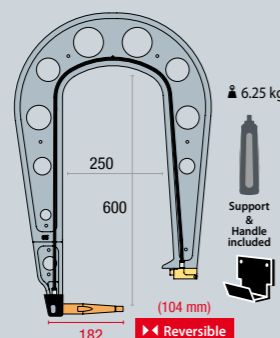

G5
8 bar/550 daN
022805

Option for G5

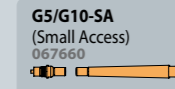

G5/G10-SA (Small Access)
067660

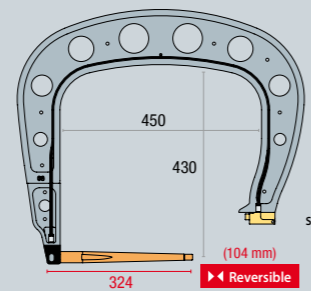

G8
8 bar/550 daN
022836

Option for G8

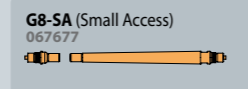

G8-SA (Small Access)
067677

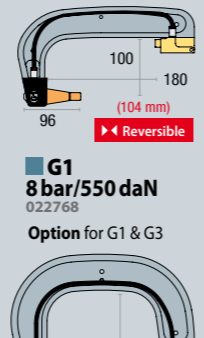

G1
8 bar/550 daN
022768

Option for G1 & G3

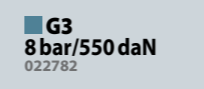

G3
8 bar/550 daN
022782

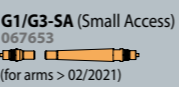

G1/G3-SA (Small Access)
067653
(for arms > 02/2021)

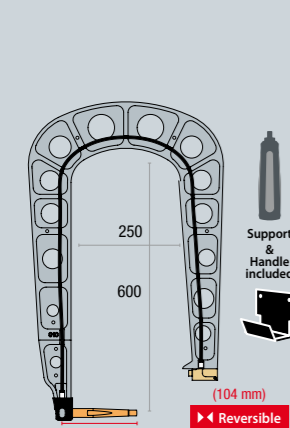

G10
8 bar/400 daN
067165

Option for G10 & G12



G5/G10/G12-SA (Small Access)
067660

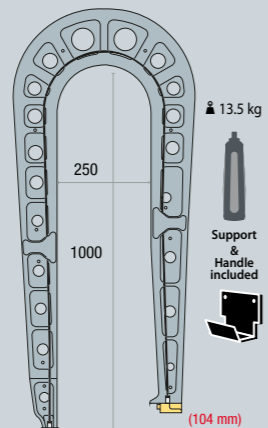

G12
8 bar/300 daN
075238



G5/G10/G12-SA (Small Access)
067660

G X **AUTOMATIC WELDING FOR X1, X2 & X6**

G9 | 8 bar/550 daN
not for PTI PREMIUM PRO

G9 with X1 Included
022881

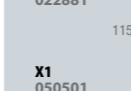

X1
050501
550 daN

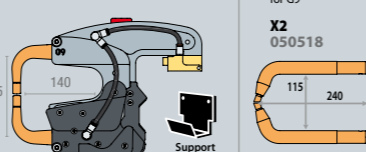

X2
050518
300 daN

G9 with X6 Included
072275

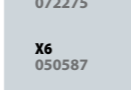

X6
050587
300 daN

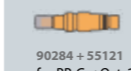

Option SD card
050914

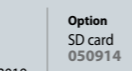

Option PCB
97449C



Option SD card
97449C

G ARMS PANELS

G2
+ G3
+ G4
022898

G2
+ G3
+ G5
063297

KIT SMALL ACCESS GENIUS for PTI GENIUS

included SA 073579

+ G1/G3-SA (Small Access)

+ G4-SA (Small Access)

+ G5/G10/G12-SA (Small Access)

+ G8-SA (Small Access)

077072

077072

077072

077072



ACCESSORIES & CONSUMABLES

X/C/G CONSUMABLES - Consommables X/C/G

Type A Cor X clamp Ø 13 mm (x6) 049987	Type D Cor X clamp Ø 13 mm (x10) 058507	TYPE G Ø 13 mm (x10) 059672	Caps type A box 048935 x40 (x6: 049987)	073449
Type B Cor X clamp Ø 13 mm / Ø 5 mm (x6) 055506	TYPE F For single sided gun Ø 13 mm (x6) 049970	Caps inclinés - Beveled X2, X4, C11 arms Ø 13 mm (x6) 049994	Caps type F box 077119 x40 (x6: 049970)	x20 (x6: 049987) x6 (x6: 049970) x2 (x1: 050617)
Contact grease Graisse contact 050440	Caps remover 050846	Anti-corrosion welding primer - Primaire de soudage anti-corrosion 076822	NEW Spot / Monopoint 049291	050068
				x10 (x20: 052239) x6 (x6: 049994)
				x18 (x6: 049987) x18 (x6: 049970)

CAP GRINDER - Affuteur de caps

Lame - Blade 052857

048966

Optimal speed: 400-800 rpm

Youtube

GYRO 360°

for BPLC/BPLCX 051737

10-14 kg

for PTI 051720

STEEL SHEET TRACTION BENCH

- Banc de traction arrache tôle - Blech-Zugbank zur Festigkeitsprüfung

052420

052321 (included)

WELD TEST KIT - Valise test soudure HLE / THLE

- Schweißtestkit im Hartschalenkoffer

050433

Barre d'arrachage / Traction bar
+ Acier doux / Mild steel 0.65 (x25) + 1.0 (x25)
+ Acier HSLA 360 - HLE 0.8 (x25) + 1.5 (x25)
+ Acier DP600 - THLE/UHLE 1.0 (x25)
+ Acier FB560 - THLE/UHLE 2.5 (x25)

ANTI-ARC PROTECTION 12V

- Protection anti-arc 12 V
- Lichtbogenschutz 12V - Protección anti-arco 12V

041318

PROTECTION COVER

- Housse de protection
- Schutzhaube

050853

for BP & PTI

NEW

for PTI GENIUS 077126

SHEETS SET

- Échantillons de tôles

Acier standard / Standard steel
0.8 (x65) + 1 (x55) + 1.5 (x35) + 2 (x25)
+ Alu
1 (x45) + 1.5 (x30) + 2 (x20)
055841

ELECTRODE FORCE SENSOR

- Capteur d'effort

052314

TANK DRAINING KIT - Kit de purge réservoir

- Kit zur Tankentleerung

058286

for GYSPOT BPLC-s7 / BPLCX-s7 / PTI-s7

SD MEMORY CARD

- Carte mémoire SD

SD CARD 050914

KIT WIFI

for Gyspot Inverter PTI GENIUS

070691

COOLING LIQUID

- Liquide de refroidissement
- Kühlmittel - Enfriamento líquido
- Refrigeração líquida

052246

10L



RIVETING

GYSPRESS 10T	77
GYSPRESS 10T PP	78
GYSPRESS PREMIUM 10T PP	79
WORKSTATION	81
ADAPTERS	83
DIES BOXES & RIVETS	84
ACCESSORIES	87



RIVETING

PNEUMATIC HYDRAULIC

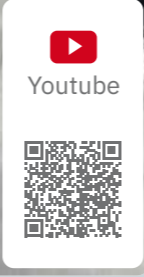

BRAS DE RIVETAGE - RIVETING ARMS - STANZNIETBÜGEL



	HR110 063310	HR210 063327	HR310 8T PP/10T/10T PP 063334
GYPRESS 8T	✓	✓	—
GYPRESS 10T	✓	✓	✓
GYPRESS 8T PUSH PULL	✓	✓	✓
GYPRESS PREMIUM 10T PUSH PULL	✓	✓	✓
GYPRESS 10T PUSH PULL	✓	✓	✓
GYPRESS 10T CONNECT	✓	✓	✓

KIT WITH HR210 + HR310
064089

CASE & FOAM WITHOUT ARMS
- Valise et mousses sans bras
077546

XT31-40
Rallonges bras HR310 pour point milieu - HR310 arm extension for middle point

Compatible 8T PP/10T/10T PP x2

066335

OPTIONS

Riveting machine support for changing accessories (arms & dies)
- Support Rivetuse pour changements d'accessoires (bras & matrice)
- Supportständer

↓ 28 x 40 x 21,5 cm
⊗ 45 x 39 x 20 cm / 7,2 kg

054158

Trolley - Chariot

↓ 74 x 51 x 81 cm
⊗ 80 x 123 x 15 cm / 44 kg

054233

Trolley + Support Chariot + Support

↓ 51 x 74 x 122 cm
⊗ 51,2 kg

055391



Pressure sensor - Capteur d'effort
062115



Hydraulic body wrenches (x2)
067325



Temporary - Serre-tôles - fasteners manual mounting

- (x10) Ø 2,4 mm 069664
- (x10) Ø 4,0 mm 069671
- (x10) Ø 4,8 mm 069688
- (x10) Ø 6,4 mm 069695

GYPRESS 10T

6.5 bar | 100 kN

10t

063303



US version 070653



Pressure gauge Psi



Discharge lever - Levier de décharge - Auslösehebel



Speed control - Contrôle de la vitesse - Regelung Werkzeuggeschwindigkeit



Pressure control - Contrôle de la pression - Druckregelung

HYDRAULIC SYSTEM
fermé - closed - geschlossen

UNIQUE 100%

No air inclusion
maintenance free, no oil refill

GYPRESS 10T COMPLETE PACKS

	HR110 063310	XT11.21 - Extension for HR110 & HR210 058644	Standard 10T tool box 053694	6 x 50 rivets RAP - Nieten SPR 048706	HR210 + HR310 064089	50kN adapter 064867	Pulling adapter kit 066076	Trolley+support 055391
GYPRESS 10T 063303 070653	✓							
GYPRESS 10T pack 1 066441		✓						
GYPRESS 10T pack 2 066458			✓					
GYPRESS 10T pack 3 064744				✓				✓

MADE IN FRANCE	AIR BAR	PRESSURE CONTROL	SPEED CONTROL	↕	⚖	📦
				cm	kg	LxWxH cm / kg
GYPRESS 10T	6.5 bar = 10 t (maxi 10 bar)	0 > 6.5 bar	+ -	39.5 x 180	6.2 (HR110 included)	58 x 50 x 15 / 12.1

GYPRESS 10T PUSH PULL

6.5 bar 100 kN
10t

063853

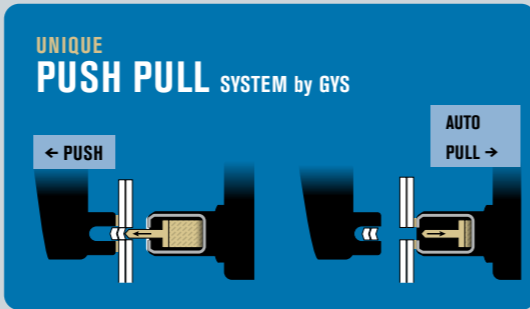
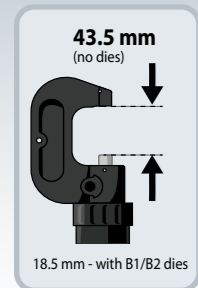

UNIQUE PUSH PULL SYSTEM by GYS

← PUSH **AUTO PULL →**

Push/Pull selection
- Sélection Push/Pull

Pressure control
- Contrôle de la pression
- Druckregelung

Speed control
- Contrôle de la vitesse
- Regelung Werkzeuggeschwindigkeit

HYDRAULIC SYSTEM
fermé - closed - geschlossen

UNIQUE 100%
No air inclusion
maintenance free, no oil refill

GYPRESS 10T PUSH PULL COMPLETE PACKS

GYPRESS 10T PUSH PULL 063853	✓						
GYPRESS 10T PP pack 1 066465			✓				
GYPRESS 10T PP pack 2 066472				✓			
GYPRESS 10T PP pack 3 065789			✓				✓

	AIR BAR	PRESSURE CONTROL	SPEED CONTROL			
MADE IN FRANCE				cm	kg	LxWxH cm / kg
GYPRESS 10T PUSH PULL	6.5 bar = 10 t (maxi 10 bar)	0 > 6.5 bar	+ -	39.5 x 180	6.7 (HR110 included)	58 x 51 x 17 / 12.8

GYPRESS PREMIUM 10T PUSH PULL

6.5 bar 100 kN
10t

077065

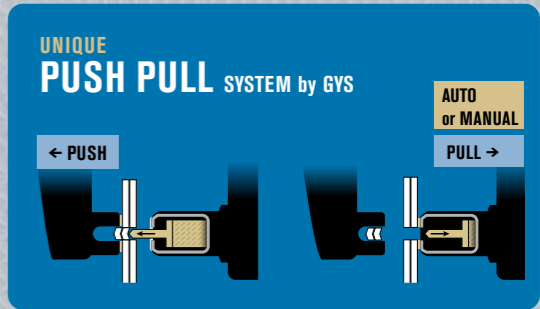
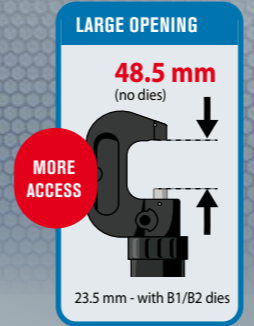

UNIQUE PUSH PULL SYSTEM by GYS

← PUSH **AUTO or MANUAL PULL →**

WORK FASTER

Push/Pull selection
- Sélection Push/Pull

MANUAL PULL MODE

Manual/Automatic selection
- Sélection Manuel/Automatique

OPENING CONTROL

Pressure control
- Contrôle de la pression
- Druckregelung

Speed control
- Contrôle de la vitesse
- Regelung Werkzeuggeschwindigkeit

US version
070660

Pressure gauge
Psi

HYDRAULIC SYSTEM
fermé - closed - geschlossen

UNIQUE 100%
No air inclusion
maintenance free, no oil refill

GYPRESS 10T PREMIUM PUSH PULL COMPLETE PACK

GYPRESS PREMIUM 10T PUSH PULL 077065 							✓

	AIR BAR	PRESSURE CONTROL	SPEED CONTROL			
MADE IN FRANCE				cm	kg	kg
GYPRESS 10T PREMIUM PUSH PULL	6.5 bar = 10 t (maxi 10 bar)	0 > 6.5 bar	+ -	39.5 x 180	6.7 (HR110 included)	59 x 50 x 16 / 13.1



GYPRESS

SYNERGIC RIVETING WORKSTATION

PNEUMATIC HYDRAULIC



UNIQUE

100%

No air inclusion
maintenance free, no oil refill

ACCESSIBILITY

16 languages

- FR
- PR
- CN
- GB
- CZ
- JP
- DE
- NL
- VN
- IT
- SE
- FI
- ES
- RU
- TR

★★★★
SYNERGIC
RIVETS
SETTINGS

Main panel



3 MODES

- MANUAL
- SYNERGIC
- CAR MANUFACTURERS

CAR MANUFACTURERS COMPATIBILITY

- ✓ VW GROUP
- ✓ MERCEDES-BENZ
- ✓ BMW
- ✓ TESLA
- ✓ FERRARI
- ✓ FORD
- ✓ RENAULT ALPINE
- ✓ GM

CONNECTIVITY

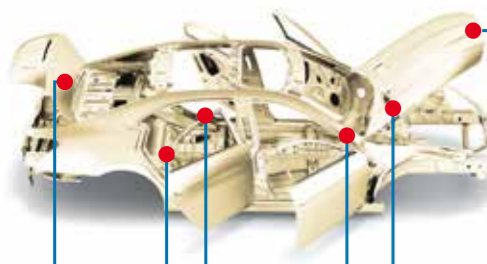

TRACEABILITY

History data export

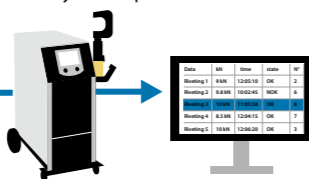

SOFTWARE UPDATE

Gyspress evolutions

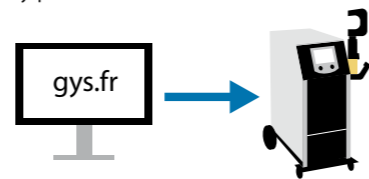

UNIQUE
**PUSH
PULL**
SYSTEM by GYS

PUSH PULL SYSTEM by GYS

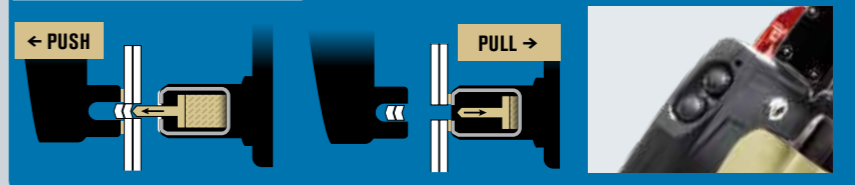

Sélection Push/Pull - Push/Pull selection

Gyspress support

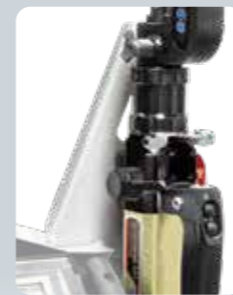

Arms support



REGULATED
PRESSURE
CONTROL

POWER
10t



Discharge lever
- Levier de décharge
- Auslösehebel

WORKSTATION GYPRESS 10T PP CONTROL

6.5 bar | 100 kN

10t

063860

included

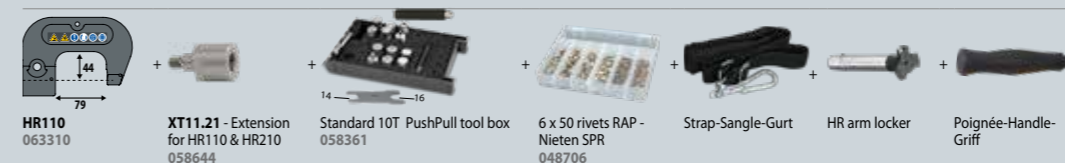

OPTIONS

Pressure gauge
- Capteur d'effort
10T PP CONTROL
071759



Youtube

Hydraulic body wrenches
for GYPRESS 10T, 10T
PushPull, 10T PP CONTROL
(x2)
067325



 MADE IN FRANCE WORKSTATION GYPRESS 10T PP CONTROL	230V	AIR BAR 6.5 bar = 10t (maxi 10 bar)	PRESSURE CONTROL 0 > 6.5 bar	SPEED CONTROL + -		
					LxWxH cm / kg 74 x 50 x 116 / 54	LxWxH cm / kg 76 x 42 x 94 / 64.4

GYPRESS CONTROL

SYNERGIC RIVETING



**BLIND RIVET ADAPTERS
- ADAPTATEURS POUR RIVETS AVEUGLES**

GYPESPRESS

Adaptators

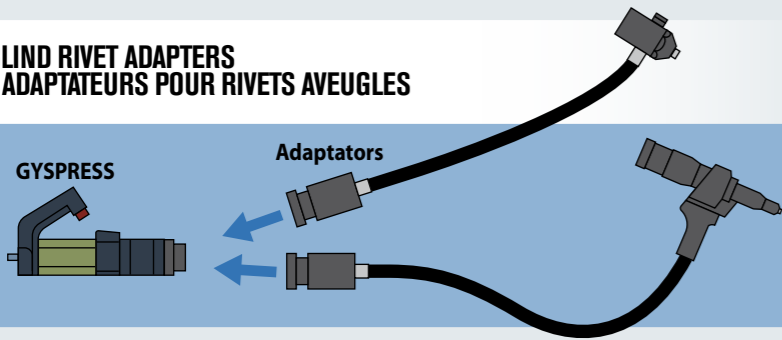

Compatibility

- GYPESPRESS 10T
- GYPESPRESS 10T PUSH PULL
- GYPESPRESS 10T PUSH PULL PREMIUM
- GYPESPRESS 10T CONNECT



Youtube

BLIND RIVET ADAPTER 24 kN - Adaptateur 24 kn pour rivets aveugles - Blindnietadapter 24 kN

HIGH ACCESSIBILITY



SPECIFIC STORAGE



24 kN STANDARD 600 mm
063822

Pour rivets POP - For BLIND rivets - Für Blindniet
Acier / Steel: Ø 4.0 → 6.4
Alu: Ø 4.0 → 7.8



INCLUDED

- 058446
- for standard rivets: Ø 3.2 x1 059221, Ø 3.6 x1 059238
- Ø 4.0 x1 059245, Ø 4.5 x1 059252

24 kN COMPACT 600 mm
077164

Pour rivets POP - For BLIND rivets - Für Blindniet
Acier / Steel: Ø 6.4
Alu: Ø 6.4 → 7.8

COMPACT HEAD



NEW

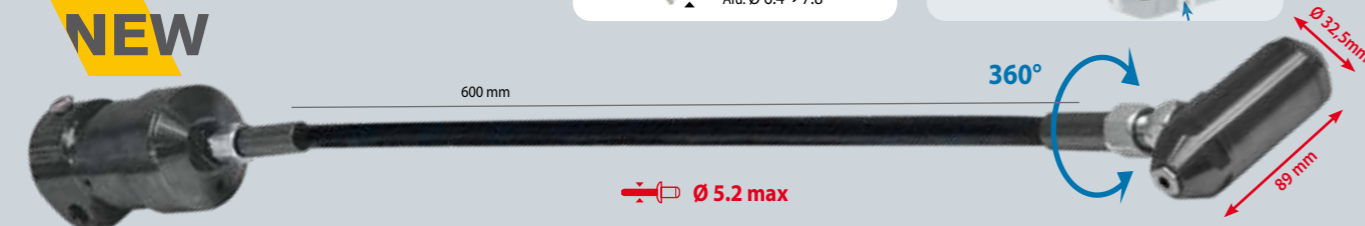

INCLUDED

- 058446
- for standard rivets: Ø 4.5 x1 059252, Ø 5.2 x1 079939
- for extraction of self piercing rivet: Rivet-extraction insert - Buse d'extraction 24kN compact Ø 5 079946

PERFECT COMBO WITH ARCPULL

SPECIAL TEARING RIVETS
- Spécial arrachage de rivets
- Spezial-Zugnieten

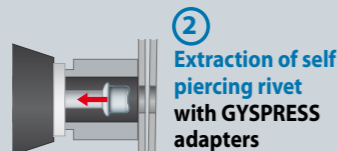
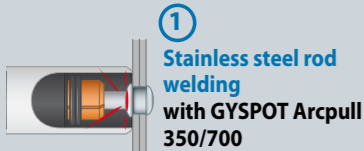

OPTION FOR GYSPOT ARCPULL (details p.17)

for GYSPOT ARCPULL 350

ARC PULL RIVET BOX1 350 - 24kN 064584					
Stainless steel nail - Tige Inox Ø 4 x 50 mm 064607	Barrel for stainless steel nail welding - Canon pour pose de tige inox 059634	Mandrel support - Support porte-goujon 059634	Nozzle + pad - Buse + patin 059641	Mandrel Ø4mm 049000	Buse d'extraction 24kN Ø 4 064683
x100	x1	x1	x1	x1	x1

BLIND RIVET ADAPTER 50 kN - Adaptateur 50 kn pour rivets aveugles - Blindnietadapter 50 kN



Stroke adjustment - Réglage de la course de traction
0 → 25 mm

50 kN 1 m
064867
4.0 kg

For BLIND rivets - Pour rivets POP - Für Blindniet

Steel / Acier: Ø 4.0 → 6.4
Alu: Ø 4.0 → 7.8

INCLUDED

Kit Standard



+ Complete kit 065987



OPTIONS

Steel / Acier: Ø 4.0 → 6.4
Alu: Ø 4.0 → 7.8

160 mm extension - Extension 160 mm - Verlängerung 160 mm
066144



Ø 8.0 → 9.8

Ø8.0/9.8mm nozzle-piece kit - Kit Rivets Ø8.0/9.8mm - Mundstückkit 8,0/9,8 mm
066045



M5 → M14
M5 → M8

Blind rivet nut pulling, Blind rivet bolt adapter kit - Kit 6 tirants pour pose d'écrous à sertir et goujons à sertir - Blindnietmuttern, Blindnietgewindebolzen-Kit
066076



OPTION FOR GYSPOT ARCPULL (details p.17)

for GYSPOT ARCPULL 350

ARCPULL RIVET BOX2 350 - 50kN 073388				
Ø 5 x 50 mm 070745	Long barrel + mandrel M5 - Canon long + mandrin M5 070738	Mandrel support - Support porte-goujon 059634	Buse + pad 059641	Buse d'extraction 50kN Ø 5 066151
x100	x1	x1	x1	x1

for GYSPOT ARCPULL 700

ARCPULL RIVET BOX 700 068452									
Ø 5 x 50 mm 070745	Long barrel + mandrel M5 - Canon long + mandrin M5 070738	Buse d'extraction 50kN Ø 5 066151	Mandrel support - Support porte-goujon 071377	Buse + pad 059641	Ring holder 059610	Rod for pulling rings - Fourche pour anneau 071384	Vis de butée	Rod for pulling rings - Fourche pour anneau 071384	Vis de butée
x100	x1	x1	x1	x1	x2	x1	x1	x1	x1

CONSUMABLES BOX FOR 50KN ADAPTER - Boîte consommables pour adaptateur 50kN - Zubehörbox für 50 kN Adapter

066168											
	Blind rivet nuts - Écrous à sertir						Blind rivet bolts - Goujons à sertir			Blind rivets - Rivets aveugles	
	M5	M6	M8	M10	M12	M14	M5	M6	M8	Ø 6.4	Ø 9.8
	22.5 → 27	24 → 28.5	23.5 → 28	0.5 → 3.0	0.5 → 3.0	0.5 → 3.0	2.8 → 4.8	3.0 → 14.0			
	x 50	x 50	x 50	x 50	x 50	x 10	x 50	x 50	x 50	x 50	x 50
	066175	066182	066199	066205	066212	066229	066236	066243	066250	066267	066274
	+ demo metal sheet - plaque de démonstration						+ x10 x10 x10			+ x10 x10	

Application of self-piercing rivets
- Pose de rivets auto-perçants
- Stanzniet-Verpressen

Application of solid rivets
- Pose de rivets pleins
- Vollniet-Verpressen

Application of Flow-form rivets
- Pose de rivets Flow-Form
- Setzen v. Fließformnieten

Extraction de rivets
- Extraction of rivets
- Niet-Auspressen

Metal sheet punching and shaping
- Perçage et formage des tôles pour rivets
- Vollniet-Lochstanzen/Prägen

DIES BOXES - Boîtes matrices - Matrizensätze

STANDARD

STANDARD 8T/10T
for 8T 10T
053694
Included XT11-21 058644

x1	x1	x1	x1	x1	x1	x1	x2	x1	x1	x1	x1	x2	x4
A1	A2	B1	B2	F1	F2	D17	E1	E2	T1	T2			
Self-piercing rivets				Flow-form rivets			Extraction		Punching		key	seals	
Ø 3.2, 3.5	Ø 3.3	Ø 5, 5.3	Ø 5.3	Ø 6 - A1/2/3 S0/1/2/3/4/5/6			Ø 3.3, 4.8	Ø 3.9, 5.3	Ø 6				x1

STANDARD 8T/10T PUSH PULL
for 8T PP 10T PP 10T CONTROL
058361
Included XT31-60 - 60 mm extension for HR310 (use with ST1, T5, T7) 057135
+ XT11-21 058644

x1	x1	x1	x1	x1	x1	x2	x1	x1	x1	x1	x2	x4	
A1	A2	B1	B2	F1	F2	D17	E1	E2	ST1	T5	T7		
Self-piercing rivets				Flow-form rivets			Extraction		Punching		key	seals	
Ø 3.2, 3.5	Ø 3.3	Ø 5, 5.3	Ø 5.3	Ø 6 - A1/2/3 S0/1/2/3/4/5/6			Ø 3.3, 4.8	Ø 3.9, 5.3	Ø 6			x1	

Low pressure
Ø 6.4 mm
KIT RMB PP05 for 10T PP 10T CONTROL
Idéal aluminium, aciers doux - Ideal for aluminum, mild steel 066366

HIGH pressure
Ø 6.4 mm
KIT RMB 08 PREMIUM for 10T 10T PP 10T CONTROL
Idéal aciers durs, Boron - Ideal for UHSS, Boron 066403

Flow-Form Ø 6 mm
KIT RMB 14 PREMIUM for 10T 10T PP 10T CONTROL
Idéal aciers durs, Boron - Ideal for UHSS, Boron 071186

Flow-Form Ø 8 mm
KIT RMB 15 PREMIUM for 10T 10T PP 10T CONTROL
Idéal aciers durs, Boron - Ideal for UHSS, Boron 071193

Ne pas utiliser avec une Gyspress 8T & 8T PP - Do not use with Gyspress 8T & 8T PP

GM

RMB 11 for 10T
071087
RMB PP04 for 10T PP 10T CONTROL
071063
Included XT31-60 - 60 mm extension for HR310

x1	x1	x1	x1	x1	x1	x1	x1	x1	x1	x3	x1	x1	x2	x2	x4
F1	F2	F6	E9	E11	T1	T2			T7	T17	T18	T19	D18	D17	
Flow-form rivets				Extraction		Punching						key	seals		
Ø 6				Ø 6, 8		Ø 6									

FERRARI

RMB 06 for 8T 10T 8T PP 10T PP 10T CONTROL
059009

x1	x1	x1	x1	x1	x1	x2	x1	x1	x1	x2	x4
B4	B5	B6	S3	S7	S8	D17	E1	E2	E13		
Self-piercing rivets					Extraction		Punching		key	seals	
Ø 3.9	Ø 4.75	Ø 3.9	Ø 4.75			Ø 3.3, 4.8	Ø 3.9, 5.3	Ø 4.75			

VW GROUP

RMB 03 for 8T 10T 8T PP 10T PP 10T CONTROL
054257

x1	x1	x1	x1	x1	x1	x1	x1	x1	x1	x1	x1	x1	x1	x1	x1	x1	x2	x4										
A1	B1	S3	S7	S8	D8	D9	D17	D1	D2	D3	D4	D13	E2	S1	S4	S5	D5	D6	D7	D10	D11	D12	D15	D16				
Self-piercing rivets				Solid rivets		Extraction										Punching		key	seals									
Ø 3.2, 3.5	Ø 5, 5.3	Ø 3.9	Ø 4.75	Ø 4	Ø 6	Ø 3.2										Ø 3.9, 5.3	Ø 3.2	Ø 5.3	Ø 8	Ø 4.8	Ø 4, 8	Ø 4	Ø 8	Ø 6				

NIO

RMB PP08 for 10T 10T PP 10T CONTROL
072404
Included XT31-60 - 60 mm extension for HR310

x1	x1	x1	x1	x1	x1	x1	x1	x1	x1	x1	x3	x1	x2	x1	x2	x4
B1	B2	F1	F2	F6	E2	E3	E9	E11	T5	ST1	T7	T17	T18	T19	D17	D18
Self-piercing rivets		Flow-form rivets			Extraction			Punching						key	seals	
Ø 5.3	Ø 5.3	Ø 6	Ø 5.3	Ø 6	Ø 6											

MERCEDES-BENZ

RMB 07 for 10T
064454
Included XT31-60 - 60 mm extension for HR3 (use with E3, E4, E5, E9, E10, E11) 057135

x1	x1	x1	x1	x1	x1	x1	x1	x1	x1	x1	x1	x1	x1	x1	x1	x1	x1	x2	
F1	F2	F3	F4	F5				E9	E10	E11	T1	T2	T3	T4					
Flow-form rivets								Extraction			Punching				clé				
Ø 6 - A1/2/3 S0/1/2/3/4/5/6								S28/38/48/58/68			S08/18	Ø 5.3, 8	Ø 6	Ø 8	Ø 6, 8	Ø 8	Ø 6	Ø 6	Ø 8

RMB PP01 for 8T PP 10T PP 10T CONTROL
058378
Included XT31-60 - 60 mm extension for HR3

x1	x1	x1	x1	x1	x1	x1	x1	x1	x1	x1	x1	x1	x1	x1	x1	x1	x1	x2	
F1	F2	F3	F4	F5				E9	E10	E11	ST1	ST2	T5	T7	T8	T10			
Flow-form rivets								Extraction			Punching				clé				
Ø 6 - A1/2/3 S0/1/2/3/4/5/6								S28/38/48/58/68			S08/18	Ø 6, 8	Ø 8	Ø 6	Ø 6	Ø 8	Ø 6	Ø 6	Ø 8

FORD

RMB PP02 for 10T 8T PP 10T PP 10T CONTROL
058835
Included XT31-60 - 60 mm extension for HR3 (use with E7 & E12) 057135

x1	x1	x1	x1	x1	x1	x1	x1	x1	x1	x1	x1	x2	x4
B1	G1	G2	G3	G4	G5	G6	E7	E12					
Self-piercing rivets										Extraction		key	seals
Ø 5, 5.3										Ø 5, 5.3		- clé	- joints

JAGUAR / LAND ROVER

RMB 02 for 8T 10T 8T PP 10T PP 10T CONTROL
054271

x1	x1	x1	x1	x2	x1	x1	x2	x4
B1	B2	B3	S8	D17	E1	E6		
Self-piercing rivets				Extraction		clé		seals
Ø 5, 5.3	Ø 5.3	Ø 4.8	Ø 4.75		Ø 3.3, 4.8	Ø 3.3, 4.8		

BMW

RMB 01 for 8T 10T 8T PP 10T PP 10T CONTROL
054240

x1	x1	x1	x1	x1	x1	x2	x4
A1	A2	B1	B2	E1	E2		
Self-piercing rivets					Extraction		key
Ø 3.2, 3.5	Ø 3.3	Ø 5, 5.3	Ø 5.3	Ø 3.3, 4.8	Ø 3.9, 5.3		

RMB 12 for 10T
071094
RMB PP07 for 10T PP 10T CONTROL
071070
Included XT31-60 - 60 mm extension for HR310

x1	x1	x1	x1	x1	x1	x1	x1	x1	x1	x1	x1	x1	x1	x1	x3	x1	x1	x2	x2	x4
B1	B3	I1	I2	I3	F1	F2	F6	E3	E13	T1	T2		ST1	T5	T7	T17	T18	T19	D18	D17
Self-piercing rivets					Flow-form rivets			Extraction		Punching						key	seals			
Ø 5, 5.3					Ø 6			Ø 3.3, 4.8		Ø 9		Ø 6								

PORSCHE

RMB 10 for 10T
069299
RMB PP06 for 10T PP 10T CONTROL
069305
Included XT31-60 - 60 mm extension for HR310

x1	x1	x1	x1	x1	x1	x1	x1	x1	x1	x1	x1	x1	x1	x1	x1	x1	x2	x2	x4
B3	F2	E9	E11		T1	T2		T5	ST1		T7		T17	T18	T19	D17			
Flow-form rivets		Extraction		Punching										key	seals				
Ø 6		Ø 6, 8		Ø 6															

TESLA

RMB 09 for 8T 10T 8T PP 10T PP 10T CONTROL
059931

x1	x1	x1	x1	x1	x1	x1	x1	x1	x1	x1	x1	x1	x1	x1	x1	x1	x2	x4
B1	H1	H2	H3	H4	H5	H6	H7	H8										
Self-piercing rivets																key	seals	
Ø 5, 5.3																- clé	- joints	

RMB 13 for 10T
071100
RMB PP03 for 8T PP 10T PP 10T CONTROL
059092
Included XT31-60 - 60 mm extension for HR3 (use with E2, E3, E9, E10) 057135

x1	x1	x1	x1	x1	x1	x2	x1	x1	x1	x1	x1	x1	x1	x1	x1	x1	x1	x1	x2	x4
B1	S7	S8	F3	F4	F5	D17	E2	E3	E9	E10				ST2	T8	T10				
Self-piercing rivets				Flow-form rivets			Extraction				Punching				key	seals				
Ø 5, 5.3				Ø 4.75			S28/38/48/58/68				S08/18									

DIES - Matrices - Matrizen

Application of self-piercing rivets
- Pose de rivets auto-perçants
- Stanzniet-Verpressen

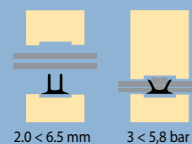

Application of solid rivets
- Pose de rivets pleins
- Vollniet-Verpressen



Pose de rivets Flow-Form
- Application of Flow-form rivets
- Setzen v. Fließformnieten

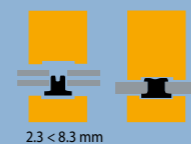

Extraction of rivets
- Extraction de rivets
- Niet-Auspressen

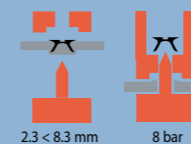

Metal sheet punching and shaping
- Perçage et formage des tôles pour rivets
- Vollniet-Lochstanzen/Prägen

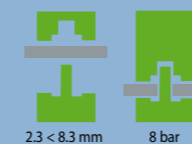

Ø 8																				
A1	A2	B1	B2	B3	B4	B5	B6	D1	D2	D3	D4	D5	D6	D7	D8	D9	D10	D11	D12	D13
055698	055704	055711	055728	055735	059016	059023	059030	055971	055988	055995	055742	056008	056015	056022	056039	056046	055674	056060	056053	055759
A1+A2				B1+B2																
054295				054301																

D15	D16	D17	D18	E1			E2	E3	E6	E7	E9	E10	E11	E12	E13	F1	F2	F3	F4
056077	056084	055681	071155	055865	054288	055766	057005	057142	057159	058606	058613	058620	058828	059085	055773	055780	055797	055803	
E1+E2																			
054318																			
													F1+F2						
													054714						

F5	F6	G1	G2	G3	G4	G5	G6	H1	H2	H3	H4	H5	H6	H7	H8	I1	I2	I3
055810	071148	057173	057180	057197	057203	057210	057227	068230	068247	068254	068261	068278	068285	068292	068308	071117	071124	071131

Ø 6						Ø 6			Ø 6			Ø 8			Ø 6.7				
S1	S3	S4	S5	S7	S8	ST1	ST2	ST3	T1	T2	T3	T4	T5	T7	T8	T10	T12	T13	
057036	057043	057050	057067	057074	057081	058071	058088	066397	057098	059078	057104	055827	055834	058019	058033	058040	058064	066373	066380
T1+T2																			
054707																			

PATENTED GYS PATENT BREVET GYS

Ø 6.7		Ø 6		Ø 8							
T14	T15	T16	T17	T18	T19	T20	T21	T22			
066410	066427	068964	066434	069312	069329	071254	069336	070936	070943	071261	070950

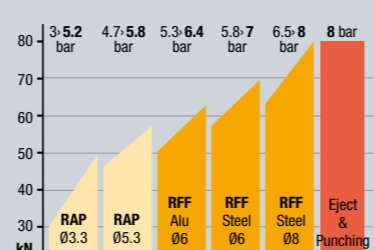

SELF PIERCING RIVETS (SPR)
- Rivets auto-perçants (RAP) - Stanznieten

Steel - Acier - Stahl

Complete box 048706							
Ø 3,3 x 3,5 mm x 50	Ø 3,3 x 4 mm x 50	Ø 5,3 x 4 mm x 50	Ø 5,3 x 5 mm x 50	Ø 5,3 x 6 mm x 50	Ø 5,3 x 8 mm x 50	Ø 5,3 x 7 mm	Ø 5,3 x 9 mm
x 200 048232	x 200 048249	x 100 048256	x 100 048263	x 100 048270	x 100 048225	x 100 048638	x 100 048645

SPECIAL CENTER PUNCH
- Pointeau centreur - Spezialkörner

048379

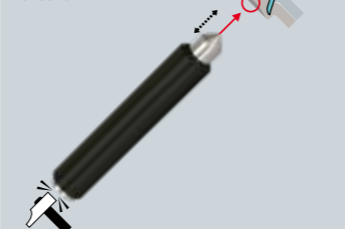

HYDROPNEUMATIC TOOL FOR BLIND RIVETS
- Riveteuse hydro-pneumatique - Hydro-pneum. Blindnietgerät

HR9

For BLIND rivets - Pour rivets POP - Für Blindniet
Steel / Acier Ø 3.2/4.0/4.8
Alu Ø 3.2/4.0/4.8

max 9 000 N

057234

Made in Taiwan



HYDROPNEUMATIC TOOL FOR BLIND RIVETS
- Riveteuse hydro-pneumatique - Hydro-pneum. Blindnietgerät

HR14

For BLIND rivets - Pour rivets POP - Für Blindniet
Steel / Acier Ø 4.0/4.8/6.4
Alu Ø 4.0/4.8/6.4

max 14 000 N

057241

Made in Taiwan



CORDLESS RIVETER - Riveteuse sur batterie
- Akku-Blindnietgerät

TWO ER20

For BLIND rivets - Pour rivets POP - Für Blindniet
Ø 4.0/4.8/5.0/6.0/6.4

max 20 000 N (6 bar)
10-20 V universal fast charger (30 min)
2.0 kg



MANUAL TOOL FOR BLIND RIVETS
- Riveteuse manuelle - Manueller Blindnietgerät

For BLIND rivets - Pour rivets POP - Für Blindniet

Steel / Acier Ø 3.2/4.0/4.8/6.4
Alu Ø 3.2/4.0/4.8/6.4

061323



Made in Taiwan

HYDROPNEUMATIC TOOL FOR RIVET NUTS - Sertisseuse hydro-pneumatique riv 998 - Hydro-pneum. Blindnietmutterngerät

RIV 998

Sealing nuts - Ecrous à sertir - Blindnietmuttern

For sealing nuts from M3 to M12
Pour la pose d'écrous à sertir M3 à M12

max 19 000 N (6 bar)
included accessories for sealing nuts:
- livré avec accessoires pour écrous à sertir:
✓ M3
✓ M4
✓ M5
✓ M6
✓ M8
✓ M10
✓ M12

055414



MADE IN ITALY

HYDROPNEUMATIC TOOL FOR BLIND RIVETS
- Riveteuse hydro-pneumatique - Hydro-pneum. Blindnietgerät

HR21

For BLIND rivets - Pour rivets POP - Für Blindniet
Ø 4.0 → 7.8

max 21 000 N (6 bar)

055407



included (x3) 058446
For standard rivets Ø 4.0 51508
For Magnarive rivets Ø 4.5 51507



MADE IN ITALY

Option HR21 extension 100 mm 063105



MIG-MAG

GMAW-FCAW

TRADITIONAL

GYS AUTO	90
----------	----

INVERTER

MULTEPEARL	91
------------	----

E GYS AUTO	92
------------	----

AUTOPULSE	95
-----------	----

ACCESSORIES & CONSUMABLES	98
---------------------------	----

MIG/MAG TRADITIONAL SYNERGIC

15 → 200 A
Ideal 0,6 mm



Capacitor
M1GYS AUTO, M3GYS AUTO
> PERFECT WELD

SYNERGIC - EASY TO USE
Réglage automatique de la vitesse \ Auto adaptative wire speed
Automatische Einstellung der Drahtgeschwindigkeit

M1 GYS AUTO

15 → 160 A Capacitor

230V • 1~
032903

208/240V • 1~
032088

with accessories

T1 GYS AUTO DV

15 → 200 A

400V • 3~ / 230V • 3~
032927

with accessories

M3 GYS AUTO

15 → 160 A Capacitor

230V • 1~
032880

2 x 4 m³ (20L)

100% READY

Ø 100 mm
Ø 200 mm
Ø 300 mm / 200 mm



Protection gas
Argon+CO₂ (Steel, Inox)
Argon (ALU/CuSi3/CuAl8)
CO₂PUR (Steel)

MIG/MAG INVERTER SYNERGIC

PFC POWER FACTOR CORRECTION
185 V ↔ 265 V

FV FLEXIBLE VOLTAGE
85 V ↔ 265 V

SR SECONDARY REGULATION
1 (A) STABLE

QR code and Youtube icon

SPECIFIC SYNERGIES FOR CAR BODY

1 MIG / SYNERGIC
Easy to use

- material → Fe, CrNi
- Ø wire → AlMg5, AISi5, CuAl8
- position → CrNi, AISi12, F.C.
- thickness → 0.5 → 6 mm
- Adjust arc length

2 MIG / MANUAL
Enter your parameters

Adjust Spot & Delay

3 MMA

4 TIG lift

MULTIPEARL AUTO

200 A

Ø 200/300

3 m, 2.5 m, 16 mm², 2 m, 16 mm²

075412



Spool Gun Torch
- Torche motorisée Spool Gun
- Spool Gun Brenner

041486

Ø 100

Ideal for
- Steel / Acier / Stahl
- Stainless steel / Inox
- Alu

4m

included 045699

SPOOL GUN + Support
for M3 GYS AUTO

038554

15L / min (FR) 041998
(UK) 040274
(NL) 040267
(IT) 038691

OPTIMAPRO 30L / min (FR) 043619
(UK) 043626
(DE) 043633
(NL) 043640

30L / min (FR) 041622
(UK) 041646
(DE) 041219
(NL) 041615
(IT) 038707

041332

M3GYS : Protection cover
- Houuse de protection
- Schutzhaube

052260

041806

MB 15 (150A) 041226

x3 x5 x3

x5 (M6-Ø0,6)
x5 (M6-Ø0,8)
x5 (Alu - M6-Ø0,8)

MADE IN FRANCE	MADE IN GYS CHINA	CE NORIA 60974/1	50/60 Hz	A	min → max	Reg	100 (spoolgun)	200	300	Electronic Control	EN60974-1 (40°C)			Original equipment Equipement d'origine Originalausstattung Equipamiento de fabrica	LxWxH cm / kg	Protected & compatible power generator (+/-15%)			
											IA (60%)	X% (I2 max)	Ø mm						
			230V 1~	16	15 → 160	6	option				400	90	140A@15%	0.6+1	0.6/0.8	0.8	78 x 38 x 67 / 56	4,5 kVA	
			208/240V 1~								400						37 x 79 x 67 / 57,5		
			230V 3~ / 400V 3~	10	15 → 200	7	option				400	110	150A@25%	0.6+1	0.6/0.8	0.8	37 x 78 x 67 / 62	5,2 kVA	
			230V 1~	16	15 → 160	6					400	90	140A@15%	0.6+1	0.6/0.8	0.8/1.0	2 x 0.8	74 x 40 x 85 / 77,5	4,5 kVA
			110V 1~	32	20 → 150	-					400	100	150 A @22%	0.6+1	0.8/1.0	0.8	79 x 30 x 67 / 37,5	7,5 kW	
			230V 1~	16	20 → 200	-					400	130	200 A @22%						



E GYS AUTO

MIG/MAG INVERTER SYNERGIC

Lastest generation
colour screen 3.5"

NEW

16 languages

- French
- English
- German
- Italian
- Spanish
- Portuguese
- Czech
- Polish
- Dutch
- Swedish
- Russian
- Chinese
- Japanese
- Vietnamese
- Finnish
- Turkish

EASY



EXPERT

Pre-gas / Creep speed / Hotstart /
Crater filler / Burnback / Post-gas



EASY TO SETUP



MODES

- MANUEL
- SYNERGIC EASY / EXPERT
- 2T
- 4T
- SPOT
- DELAI

FONCTIONS

- TRACEABILITY
- PORTABILITY
- +500 JOBS can be saved

SYNERGIES

- STEEL
- AlSi
- AlMg
- Cu Si 3 / CuAl 8
- CrNi

UPDATES

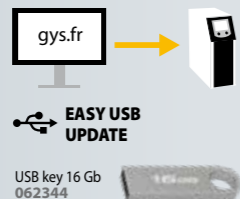

E1 GYS AUTO

10 **200 A**

230V 1~

PFC

with accessories :



075122

E2 GYS AUTO

10 **200 A**

230V 1~

PFC

with accessories :



075139

E3 GYS AUTO

10 **200 A**

230V 1~

PFC

with accessories :



075160

NEW



10 m³
(50L)

1 x

6 m

E1 GYS AUTO 200 A • × 1



PFC POWER FACTOR CORRECTION

195 V ← 265 V



100 m

NEW



2 x 4 m³
(20L)

2 x

6 m

E2 GYS AUTO 200 A • × 2

LIC ELECTRONIC

NEW



2 x 4 m³
(20L)

3 x

E3 GYS AUTO 200 A • × 3

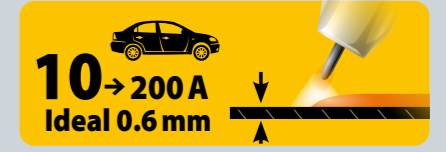

MADE IN FRANCE	E1 GYS AUTO	E2 GYS AUTO	E3 GYS AUTO	50/60 Hz	A	6 m	min → max A	200 300	Electronic Control	EN60974-1 (40°C)		Original equipment Equipement d'origine Originalausstattung Equipamiento de fabrica	LxWxH cm / kg	Protected & compatible power generator (+/-15%)
										IA (60%)	X% (I2 max)			
▪	E1 GYS AUTO	E2 GYS AUTO	E3 GYS AUTO	230V 1~	16	6 m	10 → 200	▪		145	20	Acier Type B 0.6/0.8	79 x 37 67 / 42.6	9KVA
▪	E2 GYS AUTO	E2 GYS AUTO	E3 GYS AUTO	230V 1~	16	6 m	10 → 200	▪		145	20	Acier Type B 0.6/0.8 Alu Type B 0.8/1	72 x 37 x 105 / 59.5	9KVA
▪	E3 GYS AUTO	E2 GYS AUTO	E3 GYS AUTO	230V 1~	16	6 m	10 → 200	▪		145	20	Acier Type B 0.6/0.8 Acier Type B 0.8/1 Alu Type B 0.8/1	73 x 38 x 108 / 64	9KVA



AUTOPULSE

MIG/MAG INVERTER DOUBLE PULSE

Latest generation
colour screen 5"
800 x 480 (WVGA)



Youtube

ACCESSIBILITY

- 3 interface levels
 - EASY
 - EXPERT
 - ADVANCED

- 16 languages
 - French
 - English
 - German
 - Italian
 - Spanish
 - Portuguese
 - Czech
 - Polish
 - Dutch
 - Swedish
 - Russian
 - Chinese
 - Japanese
 - Vietnamese
 - Finnish
 - Turkish

EASY



3 INTERFACE LEVELS

ADVANCED
Arc length adjustments



EXPERT
Pre-gas / Hot Start / Upslope / Downslope /
Crater filler / Post-gas



500+ JOBS can be saved



TRACEABILITY

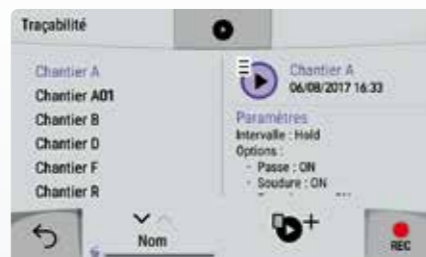

PORTABILITY



MODES

- DYNAMIC STANDARD
- PULSE
- PULSE IN PULSE
- MANUAL
- COLD PULSE**

FULLY DIGITAL

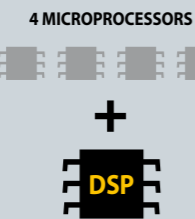

65+ SYNERGIES

Find all the synergies:
Retrouvez toutes les synergies:
Finde alle Synergien:



- STEEL
- Cu Si 3 / Cu Al 8
- ALU

UPDATES

EASY USB UPDATE



USB key 16 Gb
062344

OPTIONS

PUSH PULL TORCH 24 V



Torch gas flow-meter
- Débitmètre de bout de torche
053939

Protection cover
- Housse de protection
- Schutzhaube
052260

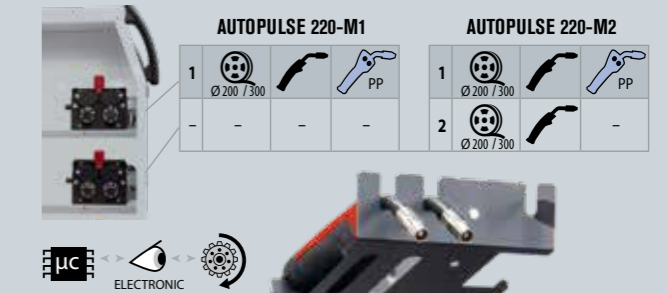

AUTOPULSE 220-M1

15 220 A 230V 1~ PFC

with accessories:



065024

AUTOPULSE 220-M1 208-240V

15 220 A 208>240V 1~ PFC

with accessories:

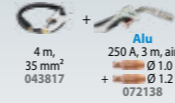

070868

AUTOPULSE 220-M2

15 220 A 230V 1~ PFC

with accessories:



069855

AUTOPULSE 220-M2 208-240V

15 220 A 208>240V 1~ PFC

with accessories:

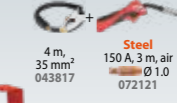

069862



PFC POWER FACTOR CORRECTION

185 V - 265 V

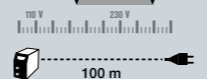

220 A • x1

220 A • x2

MADE IN FRANCE EM60974-1	50 / 60 Hz	A	Ø mm	A	SPOOLGUN	PUSH/PULL	Ø mm	Cooling system	ELECTRONIC CONTROL	EN60974-1 (40°C)		LxWxH cm / kg	Protected & compatible power generator (+/-15%)
										IA (60%)	X% (I2 max)		
AUTOPULSE 220-M1	230 V · 1~	8 m	16	0.6+1.2	10+220	-	OPTION	Air	ALU : Type B 1.0 / 1.2	150	220 A @ 20%	75 x 41 x 94 / 65.5	10 kVA
AUTOPULSE 220-M1 208-240V	208>240 V · 1~	8 m	16	0.6+1.2	10+220	-	OPTION	Air	ALU : Type B 1.0 / 1.2	150	220 A @ 20%	75 x 41 x 94 / 62.6	10 kVA
AUTOPULSE 220-M2	230 V · 1~	8 m	16	0.6+1.2	10+220	-	OPTION	Air	ACIER : Type B 0.8 / 1.0 mm ALU : Type B 1.0 / 1.2	150	220 A @ 20%	74 x 41 x 93 / 78.8	10 kVA
AUTOPULSE 220-M2 208-240V	208>240 V · 1~	8 m	16	0.6+1.2	10+220	-	OPTION	Air	ACIER : Type B 0.8 / 1.0 mm ALU : Type B 1.0 / 1.2	150	220 A @ 20%	74 x 40 x 93 / 79.8	10 kVA

AUTOPULSE
INVERTER PULSE MIG 1



MIG/MAG INVERTER DOUBLE PULSE

BODYSHOP SPECIFIC
COLD PULSE
CuSi3 Ø 0.8/1



2 x 4 m³
(20L)

3 x

8 m

PFC POWER FACTOR CORRECTION
185 V ← 265 V

100 m

AUTOPULSE 220-M3

1				PP
2			-	-
3			-	-

LIC ELECTRONIC

APPROVED EQUIPMENT

AUTOPULSE 220-M3
15 220 A 230V 1~ **PFC**

with accessories:
4 m, 35 mm² 043817 + CuSi 150 A, 3 m, air Ø 1.0 072121 + Steel 150 A, 3 m, air Ø 0.8 063754 + Alu 250 A, 3 m, air Ø 1.0 072138

AUTOPULSE 220-M3 208-240V
15 220 A 208>240V 1~ **PFC**

with accessories:
4 m, 35 mm² 043817 + CuSi 150 A, 3 m, air Ø 1.0 072121 + Steel 150 A, 3 m, air Ø 0.8 063754 + Alu 250 A, 3 m, air Ø 1.0 072138

062481

OPTIONS

PUSH PULL TORCH 24 V

MB 25
4 m
046283

Motor inside

Torch gas flow-meter
- Débitmètre de bout de torche
053939

MB 15 / MB 25 (250 A)
077089 **NEW**

x5 (Mg-Ø 0.6)
x5 (Mg-Ø 0.8)
x5 (Mg-Ø 1.0)

x5 (Mg-Ø 0.8)
x5 (Mg-Ø 1.0)
x5 (Alu - Mg-Ø 1.0)
x5 (Alu - Mg-Ø 1.2)

Protection cover
- Housse de protection
- Schutzhaube
052260

AUTOPULSE 320-T1

1				PP
2	-	-	-	-
3	-	-	-	-

LIC ELECTRONIC

AUTOPULSE 320-T3

1				PP
2				PP
3			-	-

LIC ELECTRONIC

AUTOPULSE 320-T3 208-240V

1				PP
2			-	-
3			-	-

LIC ELECTRONIC

AUTOPULSE 320-T1
15 320 A 400V 3~

with accessories:
4 m, 35 mm² 043817 + Alu 250 A, 3 m, air Ø 1.0 072138

069831



10 m³
(50L)

1 x

5 m

2 x 4 m³
(20L)

3 x

036970

OPTIONS

for AUTOPULSE 320-T3 (400 V) only

SPOOLGUN TORCH

Ideal Alu

Ø 0,8

4 m
041486

Motor inside

Ø 100

320 A • x 1

320 A • x 3

MADE IN FRANCE EN60974-1	50 / 60 Hz	A	Ø mm	min → max	SPOOLGUN	PUSH/PULL	200	Cooling system	Equipement d'origine Original equipment Originalausstattung Equipamiento de fabrica		EN60974-1 (40°C)	LxWxH cm / kg	Protected & compatible power generator (+/-15%)
									ELECTRONIC CONTROL	IA (60%) X% (I2 max)			
AUTOPULSE 220-M3	230 V · 1~	8 m	16	0.6 → 1.2	10 → 220	-	OPTION	Air		ACIER : Type B 0.6 / 0.8 ACIER : Type B 0.8 / 1.0 ALU : Type B 1.0 / 1.2	150 220 A @ 20%	75 x 41 x 94 / 80	10 kVA
AUTOPULSE 220-M3 208-240V	208 > 240 V · 1~	8 m	16	0.6 → 1.2	10 → 220	-	OPTION	Air		ACIER : Type B 0.6 / 0.8 ACIER : Type B 0.8 / 1.0 ALU : Type B 1.0 / 1.2	150 220 A @ 20%	75 x 41 x 94 / 80	10 kVA

MADE IN FRANCE EN60974-1	50 / 60 Hz	A	Ø mm	min → max	SPOOLGUN	PUSH/PULL	200 / 300	Cooling system	Original equipment Equipement d'origine Originalausstattung Equipamiento de fabrica		EN60974-1 (40°C)	LxWxH cm / kg	Protected & compatible power generator (+/-15%)
									ELECTRONIC CONTROL	IA (60%) X% (I2 max)			
AUTOPULSE 320-T1	400 V · 3~	5 m	16	0.6 → 1.2	15 → 320	-	OPTION	Air		ALU : Type B 1.0 / 1.2	260 320 A @ 35%	74 x 41 x 94 / 65.1	16 kVA
AUTOPULSE 320-T3	400 V · 3~	5 m	16	0.6 → 1.2	15 → 320	OPTION	OPTION	Air		ACIER : Type C 0.8 / 1.0 mm ALU : Type C 1.0 / 1.2	260 320 A @ 35%	75 x 40 x 94 / 82	16 kVA
AUTOPULSE 320-T3 208-240V	208-240 V · 3~	5 m	25	0.6 → 1.2	15 → 320	-	OPTION	Air		ACIER : Type C 0.8 / 1.0 mm ALU : Type C 1.0 / 1.2	260 320 A @ 35%	74 x 41 x 95 / 82	16 kVA



INDUCTION HEATING

1 200 - 22 000 kW

GYSINDUCTION 102

COMBIDUCTION 103

POWERDUCTION 105

ACCESSORIES & CONSUMABLES 108



INDUCTION HEATING

CAR BODY

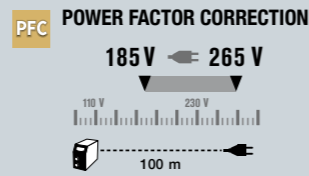

NEW

PACKS - GYSDUCTION AUTO

	PROLINER AUTO 048775	COMPLETE AUTO 053380	COMPLETE AUTO+ 056978	MECA AUTO 048812	MECA AUTO+ 056961	BODY SHOP AUTO 048799	GLASS AUTO 048805	DENT REPAIR AUTO 054981	SMART REPAIR AUTO 079847
GYSDUCTION AUTO	✓	✓	✓	✓	✓	✓	✓	✓	✓
Plastic wedges 051294	✓	✓	✓	—	—	✓	✓	—	✓
Burn off Inductor 053373	✓	✓	✓	—	—	✓	✓	—	✓
Body Inductor 053359	✓	✓	✓	—	—	✓	1 box	—	✓
Bolt Inductor 053366	✓	✓	✓	✓	✓	—	—	—	—
Remote control 055490	✓	✓	✓	✓	✓	✓	—	—	✓
Universal 800 051331	✓	1 box	—	1 box	—	—	—	—	—
Cable support 052284	✓	—	—	—	—	—	—	—	—
Dent pulling Inductor 054776	3 boxes	—	—	—	—	✓	—	—	—
Spiral inductor 054783	—	—	✓	—	—	—	—	1 box	✓



GYSDUCTION AUTO

2 400 W 230 V • 1 ~

PFC AIR

CONSUMABLES

for	for	for
Protection (x5) + Colle - Stick 053854	Protection (x1) + Colle - Stick 059108	Protection (x10) + Colle - Stick 053847



COMBIDUCTION AUTO 50LG

5 200 W 230 V • 1 ~

PFC LIQUID

065901



INCLUDED COMBIDUCTION

Glass - Décapage - Entfernen
053373

Decal - Décollage - Entkleben
053359

OPTIONS

Spiral inductor - Inducteur spirale - Spiralinduktor
054783

2.5 m 1.2 kW

800 mm 054813

800 mm 054868

SIDE	Ø	⊙	Part No.
Ø 18 mm	⊙ ≤ M8	054806	
Ø 24 mm	⊙ ≤ M12	054790	
Ø 30 mm	⊙ ≤ M16	055469	

Complete with - Complétez avec - Vervollständigen mit :

SIDE	Ø	⊙	Part No.
Ø 21 mm	⊙ ≤ M10	079953	
Ø 27 mm	⊙ ≤ M14	079960	

FRONT	Ø	⊙	Part No.
Ø 18 mm	⊙ ≤ M8	079977	
Ø 21 mm	⊙ ≤ M10	079984	
Ø 24 mm	⊙ ≤ M12	079991	
Ø 27 mm	⊙ ≤ M14	080003	
Ø 30 mm	⊙ ≤ M16	080010	

PDR : Paintless Dent Repair
- Débosselage sans peinture
- Lackschadenfreies Ausbeulen
054776

Licensed by BETAG innovation

3 m

Freezer spray - Spray refroidisseur
-50 °C
400 ml
(x 12)
048898

Adhesive for logo (x10)
051492

CE NORM. EN-60335/1	MADE IN FRANCE	A	W	Freq. kHz	Tech. PFC	* Liquid Cooling	Cable L (m)		Heating		LxWxH cm / kg	LxWxH cm / kg	Protected & compatible power generator (+/-15%)	
							Inductor	⊙	⊙	⊙				
GYSDUCTION AUTO		230 V, 1~, 50/60 Hz	16 mini	2400	35+100	—	2	2.5	M10 → 1 s	2 mm → 5 s	Ø8 → 10 s	37 x 21 x 37 / 7.5	52 x 30 x 37 / 12.9	3 kW
COMBIDUCTION AUTO 50LG		230 V, 1~, 50/60 Hz	25 mini	5200	20+80	71	8	3	M14 → 1 s	2 mm → 3 s 4 mm → 5 s	Ø10 → 10 s	46 x 43 x 75 / 60	79 x 58 x 60 / 72	6 kW



INDUCTION HEATING

1.2 → 5.2 kW

MAINTENANCE / MECHANIC / INDUSTRY

NEW

	10R	10R PRO
POWERDUCTION 10R	✓	✓
Flexible 800 mm 054813	✓	✓
Straight 800 mm 054868	✓	✓
SIDE		
Ø 18 mm ⊙ ≤ M8 054806	✓	✓
Ø 21 mm ⊙ ≤ M10 079953	✓	✓
Ø 24 mm ⊙ ≤ M12 054790	✓	✓
Ø 27 mm ⊙ ≤ M14 079960	✓	✓
Ø 30 mm ⊙ ≤ M16 055469	✓	✓
FRONT		
Ø 18 mm ⊙ ≤ M8 079977	✓	✓
Ø 21 mm ⊙ ≤ M10 079984	✓	✓
Ø 24 mm ⊙ ≤ M12 079991	✓	✓
Ø 27 mm ⊙ ≤ M14 080003	✓	✓
Ø 30 mm ⊙ ≤ M16 080010	✓	✓



PFC POWER FACTOR CORRECTION

185 V ← 265 V

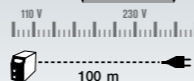

1 200 W | 230V • 1~ | AIR

POWERDUCTION 10R (5 inductors) 062504 068643

POWERDUCTION 10R PRO (12 inductors) 080195 080300

POWERDUCTION 37LG 3700 W | 230V • 1~ LIQUID 056992 072510

POWERDUCTION 39LG (C20/B1) 3700 W | 230V • 1~ LIQUID 058583

POWERDUCTION 39LG (S90) 3700 W | 230V • 1~ LIQUID 080027

POWERDUCTION 50LG 5200 W | 230V • 1~ LIQUID 055599

OPTIONS 10R

Decal - Décollage - Entkleben 066601

Loosening - Dégrillage - Lockerung 079472

BS 079489

OPTION 37LG

Cable hanger - Cable support 052284

Trolley - Chariot UNIVERSAL 800 051331

OPTION 50LG

Protection cover - Housse de protection - Schutzhaube 062733

NEW

	included	39LG C20/B1	39LG S90
C20/B1 056862	✓	✓	—
285 064485	—	—	✓
S90 058927	—	—	✓



included C20/B1 056862

MADE IN FRANCE	Cable L (m)	A		Freq. kHz	INTEGRATED TECHNOLOGY		Cable Inductor	Heating			LxWxH cm / kg	LxWxH cm / kg	Protected & compatible power generator (+/-15%)		
		W	P400		PFC	Liquid Cooling		Inductor	Heating	Heating					
POWERDUCTION 10R	230V, 1~, 50/60 Hz	10 mini	1 200	45+80	—	—	—	2	1	M10 → 1 s	2 mm → 5 s	Ø8 → 10 s	21 x 10 x 15 / 3.3	42 x 17 x 37 / 5.5	1.5 kW
POWERDUCTION 37LG	230V, 1~, 50/60 Hz	16 mini	3 700	15+30	—	—	1.51	2	2	M10 → 1 s	2 mm → 5 s	Ø10 → 15 s	56 x 26 x 29 / 13	60 x 34 x 33 / 14.5	4 kW
POWERDUCTION 39LG	230V, 1~, 50/60 Hz	16 mini	3 700	20+60	■	■	71	6	3	M12 → 1 s	2 mm → 5 s	Ø10 → 15 s	46 x 36 x 70 / 46.5	81 x 38 x 59 / 52	4 kW
POWERDUCTION 50LG	230V, 1~, 50/60 Hz	25 mini	5 200	20+60	■	■	71	8	3	M14 → 1 s	2 mm → 3 s 4 mm → 5 s	Ø10 → 10 s	46 x 43 x 75 / 53	79 x 58 x 60 / 71	6 kW



INDUCTION HEATING 11 → 22 kW



included adapter
32L + L90
064515 + 059788

4 m

included
removable
handle
068599



included
removable
handle
068599

included adapter
32L + L90
064515 + 059788

6 m



included
removable
handle
068599

included adapter
32L + L20/B4
064515 + 067882

6 m
or
10 m

- POWERDUCTION 110LG**
11 000 W | 400 V • 3~
* LIQUID
058590
- POWERDUCTION 110LG 208-240V**
11 000 W | 208-240 V • 3~
* LIQUID
065246
- POWERDUCTION 160LG**
16 000 W | 400 V • 3~
* LIQUID
057814
- POWERDUCTION 160LG 208-240 V**
16 000 W | 208-240 V • 3~
* LIQUID
065253
- POWERDUCTION 220LG**
22 000 W | 400 V • 3~
* LIQUID
6 m cable : 066861
10 m cable : 074576

OPTION

Powerduction 160/220 LG over hanging arm-pulley
- Équilibreur Powerduction 160/220 LG

079441

NEW

t° POWER HEAT CONTROLLER

t° CONTROL
80>350°C (210>660°F)

5,5m

POWER HEAT CONTROLLER
061644

Included
T° sensors
thermocouple type K
x2

Compatibility
POWERDUCTION 110LG
POWERDUCTION 110LG 208-240 V
POWERDUCTION 160LG
POWERDUCTION 160LG 208-240 V
POWERDUCTION 220LG

OPTION

Pyrometer IR
for inductor L90

1.1 m
064119

OPTIONS

Removable handle
- Poignée de lance
- Abnehmbarer Griff
for POWERDUCTION
220 - 160 - 110 LG
068599

Cooling liquid
for
POWERDUCTION
160 - 220 LG
5L
062511
10L
052246

Protection cover
- Housses de protection
- Schutzhaube
for POWERDUCTION
160 - 220 LG
050853

Protection cover
- Housses de protection
- Schutzhaube
for POWERDUCTION
110LG
062733

MADE IN FRANCE	Cable L (m)	Freq.	Liquid Cooling	Cable L (m)	Heating		LxWxH cm / kg	LxWxH cm / kg	Protected & compatible power generator (+/-15%)				
					Inductor	Heating							
POWERDUCTION 110LG	400 V, 3~, 50/60 Hz	16 mini	11 000	20+60	7l	5	4	M18 → 1 s	2 mm → 2 s 4 mm → 4 s	Ø10 → 7 s	42 x 42 x 76 / 66.5	59 x 80 x 60 / 86	15 kW
POWERDUCTION 110LG 208-240V	208-240 V, 3~, 50/60 Hz	35 mini	11 000	20+60	7l	5	4	M18 → 1 s	2 mm → 2 s 4 mm → 4 s	Ø10 → 7 s	42 x 42 x 76 / 78	59 x 80 x 60 / 90	15 kW
POWERDUCTION 160LG	400 V, 3~, 50/60 Hz	32 mini	16 000	20+60	30l	4	6	M20 → 1 s	2 mm → 2 s 4 mm → 4 s	Ø10 → 5 s	78 x 58 x 118 / 128	80 x 61 x 120 / 140	22 kW
POWERDUCTION 160LG 208-240V	208-240 V, 3~, 50/60 Hz	45 mini	16 000	20+60	30l	4	6	M20 → 1 s	2 mm → 2 s 4 mm → 4 s	Ø10 → 5 s	78 x 58 x 118 / 113.5	80 x 60 x 120 / 126	22 kW
POWERDUCTION 220LG	400 V, 3~, 50/60 Hz	32 mini	22 000	20+60	30l	4	6	M45 → 3 s	4 mm → 3 s 8 mm → 9 s	Ø10 → 4 s	70 x 60 x 120 / 98	80 x 60 x 132 / 139	22 kW
POWERDUCTION 220LG 10M	400 V, 3~, 50/60 Hz	32 mini	22 000	20+60	30l	4	10	M45 → 3 s	8 mm → 9 s 4 mm → 3 s	Ø10 → 4 s	70 x 60 x 120 / 132.5	80 x 60 x 120 / 144.5	22 kW

SMALL Ø16

INDUCTORS

* = original equipment	S90 058927	S70 061569	S180 059269	S20/B1 (20°) 064874	S180/B1 064881	S180/B2 064928	S180/B3W 067899
37 LG	✓*			✓		—	✓
39 & 50 LG				✓ with adapter 28S			
110, 160 & 220 LG				✓ with adapter 32S			

NEW

	S20/D20 078796	S90/D20 078871	S180/D20 069985
Ø 20	S20/D25 078802	S90/D25 078888	S180/D25 069992
Ø 25	S20/D30 078819	S90/D30 078895	S180/D30 070592
Ø 30	S20/D35 078826	S90/D35 078901	S180/D35 070608
Ø 35	S20/D40 078833	S90/D40 078918	S180/D40 070615
Ø 40	S20/D45 078840	S90/D45 078925	S180/D45 070622
Ø 45	S20/D50 078857	S90/D50 078932	S180/D50 070639
Ø 50	S20/D55 078864	S90/D55 078949	S180/D55 070646
Ø 55			
37 LG	✓ S20/D20-D35, S90/D20-D35, S180/D20-D35		
39 & 50 LG	✓ with adapter 28S		
110, 160 & 220 LG	✓ with adapter 32S		
Protection kit for L180/D inductors - Kit de protection pour inducteurs boucle 077386			

NEW

	S180 HEAT TUBE D37 078604	S180 HEAT TUBE D40 078611	S180 HEAT TUBE D50 078628
37 LG	—		
39 & 50 LG	✓ with adapter 28S		
110, 160 & 220 LG	✓ with adapter 32S		

ADAPTERS

	28S M28 Ø16 064485	32S M32 Ø16 064508
37 LG	—	
39 & 50 LG	✓ 28S M28 Ø16	
110, 160 & 220 LG	✓ 32S M32 Ø16	

Boxes - boîtes

28S/B type W for 39LG & 50LG 072497	32S/B type W for 110LG & 160LG 072503	L box 065796
included: S20/B1 (x1) S180/B1 (x1) S180/B3 (x1) 28S (x1) B1 (x1) B3 (x1)	included: S20/B1 (x1) S180/B1 (x1) S180/B3 (x1) 32S (x1) B1 (x1) B3 (x1)	included: L70 (x1) L180 (x1)

Trolley for inductor for adapter 32L

Chariot pour inducteur pour adaptateur 32L
075955

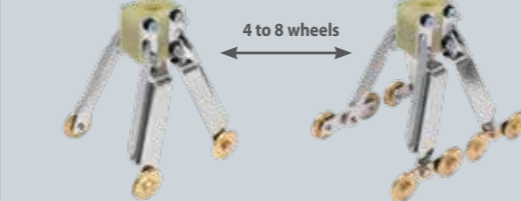

Ferrites - Ferrites - Ferritaufsatz

B1 053823	B1 (x5) 079380	B2 053458	B3 067875	B4 053755	B5 079489	Spiral 069701

Glue kit for inductor

Kit de colle pour inducteur
075948



LARGE Ø32

INDUCTORS

* = original equipment	L90 (90°) 059788	L70 (70°) 059771	L180 059795	L180/Spiral 065000	L20/B4 067882	L20 Alu Glove 069114
37 LG	—					
39 & 50 LG	✓ with adapter 28L					
110, 160 & 220 LG	✓ with adapter 32L*		✓ with adapter 32L		✓ with adapter 32L*	✓ with adapter 32L

NEW

	L20/D60 078956	L90/D60 079106	L180/D60 069923
Ø 60	L20/D70 078963	L90/D70 079113	L180/D70 069930
Ø 70	L20/D80 078970	L90/D80 079120	L180/D80 069121
Ø 80	L20/D90 078987	L90/D90 079137	L180/D90 069947
Ø 90	L20/D100 078994	L90/D100 079144	L180/D100 069954
Ø 100	L20/D110 079007	L90/D110 079151	L180/D110 069961
Ø 110	L20/D120 079014	L90/D120 079168	L180/D120 069978
Ø 120	L20/D130 079021	L90/D130 079175	—
Ø 130	L20/D140 079038	L90/D140 079182	—
Ø 140	L20/D150 079045	L90/D150 079199	—
Ø 150	L20/D160 079052	L90/D160 079205	—
Ø 160	L20/D170 079069	L90/D170 079212	—
Ø 170	L20/D180 079076	L90/D180 079229	—
Ø 180	L20/D190 079083	L90/D190 079236	—
Ø 190	L20/D200 079090	L90/D200 079243	—
Ø 200			
37 LG	—		
39 & 50 LG	✓ with adapter 28L		
110, 160 & 220 LG	✓ with adapter 32L		
Protection kit for L180/D inductors - Kit de protection pour inducteurs boucle 077386			

NEW

	L90 BRAZ 16 Ø 1/2" / 16 mm 076907	L90 BRAZ 28 Ø 1" / 28 mm 076921	L180 BRAZ 16 Ø 1/2" / 16 mm 076914	L180 BRAZ 28 Ø 1" / 28 mm 076938
37, 39 & 50 LG	—			
110, 160 & 220 LG	✓ with adapter 32L*			
Protection kit for BRAZ inductors - Kit de protection pour inducteurs brasage 077515				

	L180R X Production on request	
37, 39 & 50 LG	—	
110, 160 & 220 LG	✓ with adapter 32L	

ADAPTERS

	28L M28 Ø32 064492	32L M32 Ø32 064515
37 LG	—	
39 & 50 LG	✓ 28L M28 Ø32	
110, 160 & 220 LG	✓ 32L M32 Ø32	

COMPLETE (Ø 28)

	C20/B1 (20°) 056862	C180/B1 (90°) 056879	C180/B2 (90°) 056886
37 LG	—		
39 & 50 LG	✓*		
110, 160 & 220 LG	—		



PLASMA CUTTING

EASYCUT	112
CUTTER	113



CUTTER

PLASMA

1~

COMPRESSOR COMPRESSOR INSIDE

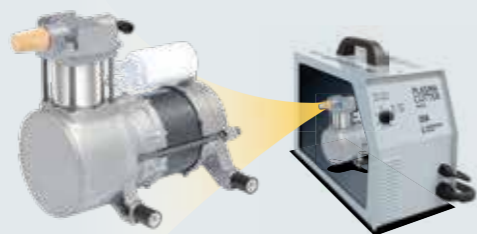

AD ANTI-DUST VENTILATION CORRIDOR

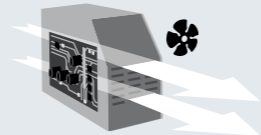

PFC POWER FACTOR CORRECTION

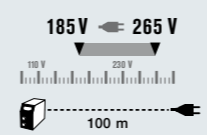

FV FLEXIBLE VOLTAGE

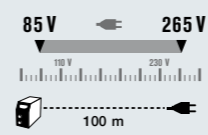

CNC COMPUTER NUMERICAL CONTROL

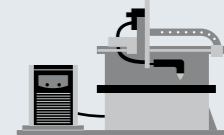

AIR FILTER

PFC EN 61000-3-12 POWER FACTOR CORRECTION

NEW NAME

DIGITAL (PRESSURE SENSOR)



INCLUDED: 8mm



IDEAL CARBODY REPAIR

PFC EN 61000-3-12 FV FLEXIBLE VOLTAGE

DIGITAL (PRESSURE SENSOR)



INCLUDED: 8mm

DIGITAL (PRESSURE SENSOR)



COMPRESSOR Compressor inside

	EASYCUT K25
230 V • 1 ~	
25 A	Fe 8 mm Al/CrNi 6 mm
P400 COMPRESSOR	
	+
TPT 25, 4 m	2 m, 10 mm ²
068063	

	EASYCUT K35F
230 V • 1 ~	
35 A	Fe 15 mm Al/CrNi 10 mm
P400 PFC AD COMPRESSOR	
	+
MT35K, 4 m	2 m, 10 mm ²
031036	

	EASYCUT 25
230 V • 1 ~	
25 A	Fe 8 mm Al/CrNi 6 mm
	+
TPT 25, 4 m	2 m, 10 mm ²
065543	
	+
072046	

	CUTTER 30FV
110 → 230 V • 1 ~	
30 A	Fe 15 mm Al/CrNi 10 mm
P400 PFC FV	
	+
TPT 40, 4 m 060753	2 m, 10 mm ²
013858	

	EASYCUT 40
230 V • 1 ~	
40 A	Fe 18 mm Al/CrNi 15 mm
	+
TPT 40, 4 m 060753	2 m, 10 mm ²
029743	

	CUTTER 45 CT
110 → 230 V • 1 ~	
45 A	Fe 30 mm Al/CrNi 20 mm
P400 PFC FV GRID CUT AD IP 23 CNC ANALOGIC	
	+
TPT 40, 4 m	2 m, 10 mm ²
014787	
	+
TPT 40, 4 m	2 m, 10 mm ²
013629	
	+
MT 70, 6 m	2 m, 10 mm ²
062962	

OPTIONS

COMPAS for TPT 40, TPT 25, MT 25K / MT 35K
x1 040199
040205
R max = 670 mm

Consumables				
	MT25K	TPT25	MT35K	TPT40
	x4 040182	x4 040236	x4 040229	x4 040236
	x10 040151	x10 040212	x10 040212	x10 040212
	x2 040175	x2 040175	x2 040175	x2 040175
	x10 040168	x10 040168	x10 040168	x10 040168
Box - Coffret	039971	070721	039964	039957

Trolley - Chariot		
PLASMA 600 040298	Universal 800 039568	Jobsite XL 039568
↓ 39 x 58 x 62 cm / 8.2 kg	↓ 48 x 62 x 81 cm / 17.6 kg	↓ 60 x 59 x 115 cm / 18.4 kg
⊗ 63 x 30 x 11 cm / 8.8 kg	⊗ 81 x 52 x 15 cm / 18.1 kg	⊗ 66 x 47 x 20 cm / 19.6 kg

Compressed air cleaning filter for Plasma Cutter 40 - Filtre déshumidificateur spécial Plasma 039728
Filter cartridge - Cartouche pour filtre 039735

CE NORM. EN60974-1	I ₂	mm						INTEGRATED TECHNOLOGY							AIR SYSTEM			EN 60974-1 (40°C)		Protected & compatible power generator (+/-15%)					
		Coupe max Severance cut	Coupe propre Clean cut	Perçage Piercing	P400	PFC	FV	GRID CUT	AD	IP23	CNC	COMPRESSOR	min	ideal	max	I _{60%}	X% I _{2max}	100%	LxWxH cm / kg						
MADE IN FRANCE	EASYCUT K25	230V1~	13	10 → 25	8	6	6	4	—	—	—	—	—	—	—	—	—	included	15 A	26%	—	53 x 31 x 48 / 19	4.1 kW	5.9 kVA	
	EASYCUT K35F	230V1~	13	10 → 35	15	10	10	8	—	—	—	—	—	—	—	—	—	included	28 A	30%	20 A	62 x 33 x 57 / 27	8 kW	10 kVA	
MADE IN GYS CHINA	EASYCUT 25	230V1~	13	10 → 25	8	6	6	4	—	—	—	—	—	—	—	—	—	2.5 bar 115 L/min	6.5 bar	15 A	30%	10 A	45 x 25 x 35 / 9.7	—	—
	EASYCUT 40	230V1~	16	10 → 40	20	15	15	12	—	—	—	—	—	—	—	—	—	2.5 bar 115 L/min	9 bar	19 A	25%	32 A	51 x 29 x 37 / 14.3	6.5 kW	6 kVA
MADE IN FRANCE	CUTTER 30FV	230V1~	16	10 → 30	15	10	10	8	—	—	—	—	—	—	—	—	—	5 bar 115 L/min	7 bar	23 A	30%	20 A	51 x 29 x 37 / 14.3	6.5 kW	6 kVA
		110V1~	32	10 → 30	32	10	10	8	—	—	—	—	—	—	—	—	—	5 bar 115 L/min	7 bar	19 A	25%	15 A	—	—	
		230V1~	16	15 → 45	20	15	15	10	8	6	—	—	—	—	—	—	—	5 bar 115 L/min	7 bar	41 A	50%	32 A	—	—	
CUTTER 45CT	TPT 40	110V1~	32	15 → 30	15	10	10	8	—	—	—	—	—	—	—	—	—	5 bar 115 L/min	7 bar	21 A	25%	17 A	—	—	
	MT 70	230V1~	32	15 → 45	30	20	25	15	12	10	—	—	—	—	—	—	—	5 bar 185 L/min	7 bar	41 A	50%	32 A	51 x 31 x 47 / 16.4	10.5 kW	8 kVA
		110V1~	32	15 → 30	15	10	10	8	—	—	—	—	—	—	—	—	—	5 bar 185 L/min	7 bar	21 A	25%	17 A	—	—	

EASYCUT / CUTTER

PLASMA CUTTING



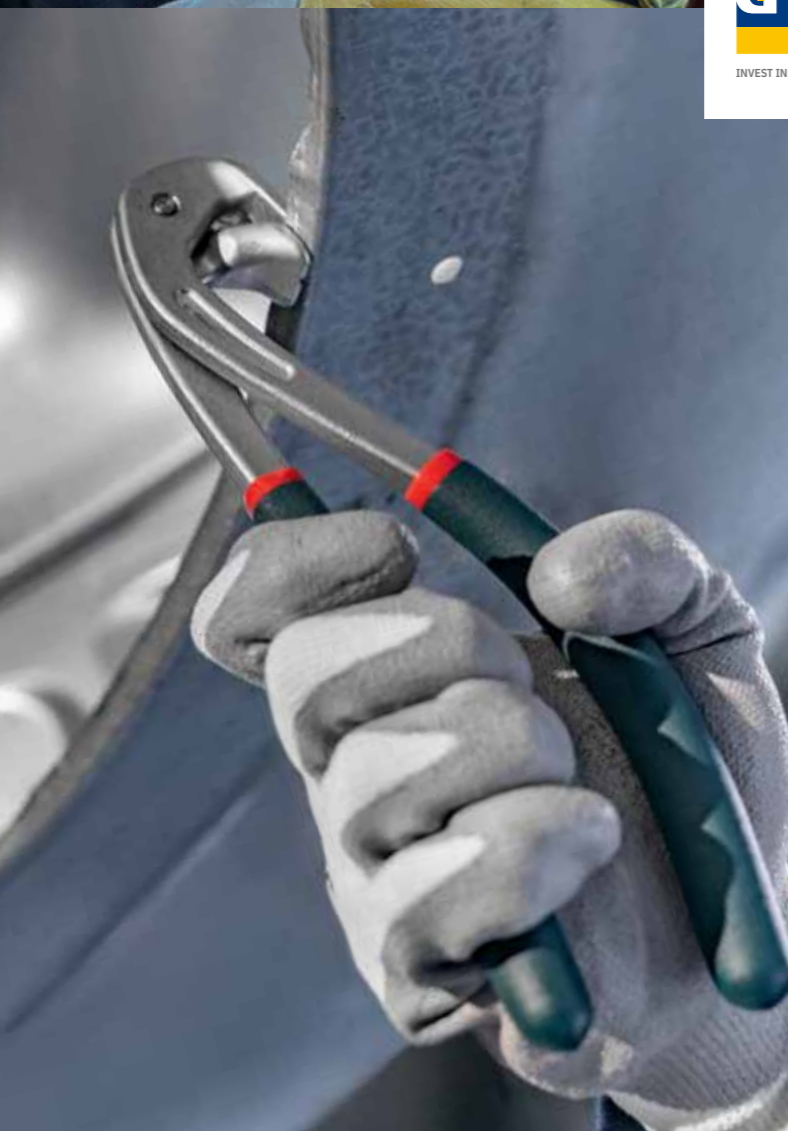

+ ACCESSORIES

WELDING HELMETS	117
FUME EXTRACTION	121
WINDSCREEN REPAIR	122
BUMPER REPAIR	124
HAND TOOLS	126
PNEUMATIC TOOLS	128
SANDING & DUST EXTRACTION	130
WORKING LIGHTS	132
WORKING SUPPORTS	134
SAFETY PROTECTION	137

HELMETS

TECHNOLOGY

	Intensity (A)															
	1.5	70	100	125	150	175	200	225	250	300	350	400	450	500	600	
MAG	8	9	10			11			12			13				
MIG			9	10		11			12		13	14				
MIG light alloys				10	11	12			13		13					
PLASMA			9	10	11	13										

Teinte initiale - Initial shade



Classic

ULTRA CLEAR

Spectre de couleur - Spectrum view

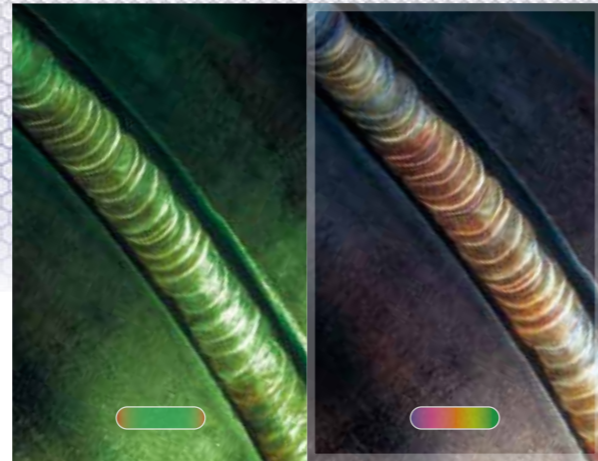

Classic

TRUECOLOR

Sensitivity sensors - Capteurs sensibles

Classic

HIGH SENSIBILITY



Sensors x2



Sensors x4

Classification - X=/X=/X=/X=

1/1/1/1 = PERFECT QUALITY

(1) Optical quality (distortion). (2) Light diffusion (contrast). (3) Variation of light transmission (homogeneities of the dark shade). (4) Angular light (diagonal light ray filter).

(1) Qualité optique (distorsion). (2) Diffusion de la lumière (contraste). (3) Variation de la transmission lumineuse (homogénéités de la teinte foncée). (4) Lumière angulaire (filtre de rayons lumineux diagonaux).

(1) / (2) / (3) / (4)

Headgear - Serre-tête



Simple



Multi



MULTI PRO



MULTI PREMIUM
Comfortable back

WELDING HELMETS

9-13

IDEAL



LCD GYSMATIC 9/13 G
TRUECOLOR
043909

◀ 100 x 60 mm | □▶ 0.08 ms



WELDING HELMETS

5-9/9-13



LCD FIREMAN 9-13
TRUECOLOR
062269

◀ 100 x 49 mm | □▶ 0.1 ms



◀ 100 x 67 mm | □▶ 0.1 ms



ZEUS 5-9/9-13 G
INDIAN
038332



ZEUS 5-9/9-13 G
FIRE
044098



ZEUS 5-9/9-13 G
COSMIC
044104

OPTIONS



Sac pour masque de soudage - Carry bag for helmet welding
043299



066656



Bandeau anti-transpiration - Antiperspirant - headband
043466 for Simple, Multi, Multi Premium
062627 for Multi Pro
070844 for Gysmatic 9/13 Air, Gysmatic 5/13 Air XXL



Loupe - Magnifying glass for Zeus, Ergotech & Alien True Color
x1 042780
zoom x2 042780
zoom x3 064140

LENSES - Verres - Schutzgläser	Size		TRUECOLOR	HF	DELAY	Sensitivity	Zoom	Magnifying Glass	Weight	Brand							
	Model	Part No.															
	226 x 106 (x5)	045781	103.6 x 54 (x5)	040809	LCD FIREMAN 9-13 TRUECOLOR	3/5-9/9-13	0.10 ms	—	0.15 > 0.8 s	1/1/1/2	2	100x49 mm	—	☀	Multi	490 g	Gys
	114x133 (x10)	043893	G: 106 x 66 (x10)	043886	LCD GYSMATIC 9/13 G TRUECOLOR	4-9>13	0.08 ms	✓	0.10 > 0.90 s	1/1/1/2	4 HIGH SENSIBILITY	XL: 100x60 mm	✓	☀ +2 (CR 2450)	Simple	580 g	Gys
	114 x 133 (x10)	043893	103.7 x 69.5 (x5)	043695	ZEUS	4-5>9/9>13	0.10 ms	—	0.15 > 0.8 s	1/1/1/2	4	XL: 100x67 mm	✓	☀ +2 (CR 2450)	Multi	520 g	Gys

HELMETS

5-9/9-13

ERGOTECH +



ERGOTECH + 5-9/9-13 SILVER
068650



ERGOTECH + 5-9/9-13 BLACK
068667

< 100 x 67 mm
 GRIND

 CLASS 1/1/1/1
 TRUECOLOR
 Multi Premium

PANORAMIC

APOLLO +

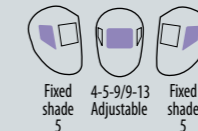

Fixed shade 5
4-5-9/9-13 Adjustable
Fixed shade 5



APOLLO + 5-9/9-13 G TRUECOLOR
068681

< 100 x 67 mm
 GRIND

 CLASS 1/1/1/1
 ULTRA CLEAR 3
 TRUECOLOR
 PANORAMIC
 Multi Premium



ERGOTECH + 5-9/9-13 DREAM
068674



Multi Pro



GYSMATIC XXL TRUECOLOR
037236

< 100 x 83 mm
 GRIND

 CLASS 1/1/1/1
 DIGITAL
 TRUECOLOR

ALIEN +



ALIEN XXL + TRUECOLOR
068698



< 100 x 90 mm
 GRIND

 CLASS 1/1/1/1
 ULTRA CLEAR 3
 TRUECOLOR
 Multi Premium



GYSMATIC XL TRUECOLOR
037908



< 100 x 60 mm
 GRIND

 CLASS 1/1/1/1
 TRUECOLOR

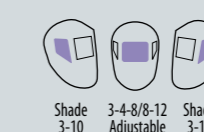

Shade 3-10
3-4-8/8-12 Adjustable
Shade 3-10



PANORAMIC 3XL TRUECOLOR
037281

< 114 x 85 mm
 GRIND

 CLASS 1/1/1/1
 ULTRA CLEAR 3
 TRUECOLOR
 PANORAMIC

OPTIONS

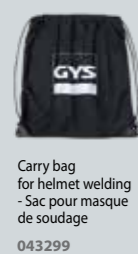

Carry bag for helmet welding
- Sac pour masque de soudage
043299



Antiperspirant-headband
- Bandeau anti-transpiration
066656



Magnifying glass - Loupe
for Zeus, Ergotech & Alien True Color
x1
zoom x2 042780
for Multi Pro x2
070844
for Gysmatic 9/13 Air, Gysmatic 5/13 Air XXL



LENSES - Verres - Schutzgläser



Shade	Shade	Grind	Filter	Anti-fog	Power	Class	Truecolor	HF	Delay	Light	Shade	Sensitivity	Lens Size	Options	Brand	Weight				
114 x 133 (x10)	043893	103.7 x 69.5 (x5)	077102				ERGOTECH +	3-5-9/9-13		0.10 ms	✓	0.15 > 0.8 s	1/1/1/1	4 HIGH SENSITIVITY	XL : 100x67 mm	✓	☀ +2 (CR 2450)	Multi Premium	580 g	Gys
114 x 133 (x10)	043893	104 x 96 (x5)	043596				ALIEN XXL + TRUECOLOR	3-5-9/9-13		0.10 ms	✓	0.15 > 0.8 s	1/1/1/1	4 HIGH SENSITIVITY	XXL : 100x90 mm	-	☀ +2 (CR 2032)	Multi Premium	560 g	Gys
110 x 90 (x5)	040816	106 x 66 (x10)	043886				GYSMATIC XL TRUECOLOR	4-5-9/9-13		0.08 ms	✓	0.1 > 0.9 s	1/1/1/1	4 HIGH SENSITIVITY	XL : 100x60 mm	✓	☀ +2 (CR 2450)	Simple	540 g	Gys
114 x 133 (x10)	043893	106 x 89.5 (x10)	046825				GYSMATIC XXL TRUECOLOR	4-5-9/9-13		0.10 ms	✓	0.1 > 0.9 s	1/1/1/1	4 HIGH SENSITIVITY	XXL : 100x83 mm	✓	☀ +2 (CR 2450)	Multi Pro	680 g	Gys
114 x 133 (x10)	043893	103.7 x 69.5 (x5)	077102				APOLLO + 5-9/9-13 G	3-5-9/9-13 + 2x:5		0.10 ms	-	0.15 > 0.8 s	1/1/1/1	4 HIGH SENSITIVITY	XL : 100x67 + 2x103.7x69.5 mm	✓	☀ +2 (CR 2450)	Multi Premium	580 g	Gys
390 x 150 (x3)	037311	special kit (x1)	037304				PANORAMIC 3XL TRUECOLOR	3-4-8/8-12 + 2x:3-10		0.15 ms	✓	0.15 > 0.8 s	1/1/1/1	4 HIGH SENSITIVITY	114x85 + 2x(68x80) mm	-	☀ +2 (CR 2450)	Multi	610 g	Gys



Multi Premium

Multi Premium

Multi Pro

Multi Premium

Multi Premium

Multi Pro

Multi Premium

Multi Premium

HELMETS VENTILATED

IDEAL

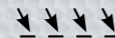

DIGITAL MEMORY & REGULATIONS ELECTRONIC

memory saving x3



**LCD GYSMATIC 9/13 G
AIR TRUECOLOR**
065727
069602

100 x 60 mm

0.08 ms



included with LCD
GYSMATIC 9 / 13 G
TRUECOLOR

**GYSMATIC 5/13 AIR XXL
TRUECOLOR**
047846
028852

100 x 83 mm

0.1 ms

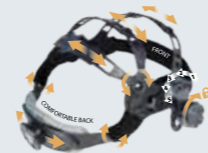

Multi Pro

**Filtration class
EN 12941 : TH2 P R SL**
Air 165 / 200
220 L/min
Battery included

**OPTION
Filter TH3**
065734



Battery charger
037472
028869



Battery included
037465



038424 x1



038417 x5

LENSES
- Verres
- Schutzgläser

			TRUECOLOR	HF	DELAY									MASK BRAND		
114 x 133 (x10)	043893 (x10)	G: 106 x 66 (x10)	043886	LCD GYSMATIC 9/13 G TRUECOLOR	4-9>13	0.08 ms	✓	0.10>0.90 s	1/1/1/2	4 HIGH SENSITIVITY	XL: 100x60 mm	✓	+2 (CR 2450)	Simple	580 g	Gys
114 x 133 (x10)	043893 (x10)	106 x 89,5 (x10)	046825	GYSMATIC 5/13 AIR XXL TRUECOLOR	3-4>8 / 8>13	0.10 ms	✓	0.1 > 0.9 s	1/1/1/1	4 HIGH SENSITIVITY	XXL: 100x83 mm	✓	+2 (CR 2450)	Multi Pro	680 g	Gys

FUME EXTRACTION SYSTEMS - Aspirateurs de fumée - Rauchgasabsauggerät

UNI 2.0 RE

- 400V 3~
 - 50 Hz
 - 1100 W
 - 1500 m³/h max
 - arm 3 m
 - no plug
 - 100 kg
 - extraction 0.5 m/s
- 061545



Ø 150 mm

Included
Pré filtre, treillis Aluminium
Class of filtration G3 EN 779
+ **Filtre - Coal Filter EPA E12**
EN 779, Filtration >99.5 %
046467

Options
Filtre à charbon actif -
Coal filter
✓ UNI 2.0 RE
064522

EVO 2.1 RE

- 230V 1~
 - 50 Hz
 - 1100 W
 - 1200 m³/h max
 - occasional
 - arm 3 m
 - included
 - 85 kg
- 061552



Ø 150 mm

792 mm

347 mm

Patented - Breveté

Included
Pré filtre, treillis Aluminium
Class of filtration F15 G2 EN 779
+ **Filtre - Coal Filter HEPA H13**
EN 779, Filtration >99.95%
046498

FUME EXTRACTION TORCHES - Torches aspirantes - Rauchgas-Absaugbrenner - Antorcha con aspiración de humos



BINZEL

	Steel/Stainless steel - Acier/Inox - Stahl/Edelstahl			
	AIR		LIQUID	
	150 A	250 A	350 A	500 A
original equipment	M6	M6	M8	M8
Ø	Ø0.8	Ø1.0	Ø1.2	Ø1.2
X % 40°C - ArCO ₂	150A - 60%	200A - 60%	290A - 60%	380A - 100%
GRIP	GRIP	GRIP	GRIP	GRIP
L	3 m	3 m	4 m	4 m
Ref.	043251	040540	040557	040564

For fume Extraction Torches - Pour torches aspirantes

BINZEL
073715



- 230V / 1 ~ , 1100 W
- 230 m³/h max
- 190 mbar max
- 25 kg, 590 x 425 x 825 mm
- 76 db
- Filter auto cleaning system - Système de nettoyage automatique du filtre - Automatische Filterabreinigung

Filtre Classe M, EN 60335-2-69

included : 5 m, Ø50



- External evacuation Ø50 (hose not included)
- Évacuation extérieure Ø50 (tuyau non inclus)

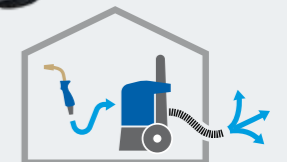

PROFESSIONAL BOX SET FOR WINDSCREEN REMOVAL - Coffret de découpe pare-brise
- Frontscheiben-Trennsystem für Akkuschrauberbetrieb

MADE IN
HIGH
QUALITY
GERMANY



057654

included
Axe enrouleur
068100

included
65 m
resistance 170 kg
Ø 0.79 mm
058125

optional
65 m
resistance 190 kg
Ø 0.92 mm
069275



OSCILLATING PNEUMATIC SAW FOR WINDSCREEN REMOVAL - Couteau pneumatique de découpe pare-brise
- Druckluft-Trennmesser für Windschutzscheiben

057623



Included
57 mm
057845

90 mm
057852

8 mm
057876

35 mm
057838

U
36 mm
057869

REMOVAL TOOL FOR WINDSCREEN WIPER ARMS - Extracteur d'essuie-glace - Wischerarm-Abzieher

UNIVERSEL
057630



EXPERT

Accès difficile
- Difficult access
057647



SUCTION LIFTING PADS - Ventouses - Saugnapfwerkzeug für Spiegelgläser

056695



051966



x6
057609



WINDSHIELD CUTTING KIT - Système de découpe pare-brise à cliquet
- Set zum Lösen von Windschutzscheiben

054738

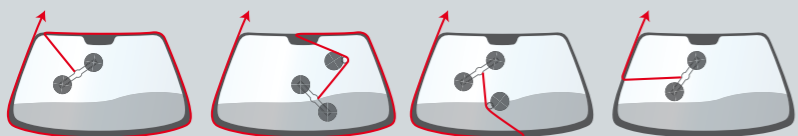

DASHBOARD PROTECTOR - Protections tableau de bord
- Armaturenbrett Schutz

053120



WINDSHIELD CUTTING TOOL - Outil découpe pare-brise
- Windschutzscheiben Demontage-Set

051935



WINDSCREEN JOINT-CUTTING KIT - Kit découpe joint de pare-brise - Scheibentrenn-Werkzeug-Set

051898

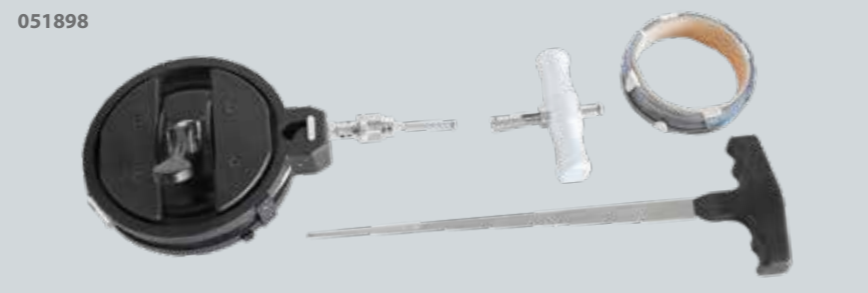

Corde à piano torsadé (22 m)
- Windscreen seal cutting wire
(twisted)
- Piano-Schneiddraht, gedreht,
22 m Rolle
051911

Corde à piano carré (50m)
- Windscreen seal cutting wire
(square)
- Vierkant-Draht,
50 m Rolle
051881

COMPRESSED AIR POLISHER - Renov'Polycarbonate - Druckluftpolierer

Complete pack

1 orbital sander
+ 1 polisher
- 1 poncuse orbitale
+ 1 lustreuse

052086



2 SPEED

+

+

+

052055

052062

052079

+

+

sander Ø75

057494

polisher Ø75
058224

Ø 76

P 500 (x 10)
P 800 (x 10)
P 1500 (x 10)
P 3000 (x 10)



P 500 x 50 052017
P 800 x 50 052024
P 1500 x 50 052031
P 3000 x 50 052048

HOT STAPLER FOR BUMPER REPAIR - Agrafeuse pour réparation pare-chocs - Stoßstangen Reparatur Kit

052925



INCLUDED:
x20 x20 x20 x20 x20

MADE IN TAIWAN

PORTABLE
Battery operated - Sur batterie
058118

included
Li-ion battery 3.7 V
048669
included adapters:
EUR, UK, USA & AUS

Charger included
048652

MADE IN TAIWAN



INCLUDED:
Ø 0.6, x100 Ø 0.8, x100
Ø 0.6, x100

Adjustable

Staples - Agrafes

Inside corner - Angle interne étroit Ø 0.7 mm	Crack alignment - Alignement de fissure Ø 0.7 mm	Large crack - Fissure importante Ø 0.7 mm	Internal angle - Angle interne Ø 0.7 mm	External angle - Angle externe Ø 0.7 mm
x 100 047990	x 100 047983	x 100 047976	x 100 047969	x 100 047952
052413				
= x 50	+ x 50	+ x 50	+ x 50	+ x 50

PIERCING KIT FOR BUMPER SENSORS - Coffret de perçage pare-chocs pour détecteurs - Lochwerkzeug für Stoßfänger



PRO+
059139

Ø 17-18-18,2
19-20-22,5-24
26-26,7-32 mm



FREEZER

Freezer spray
- Spray refroidisseur

-50 °C

400 ml

(x 12)
048898



TOOL FOR REMOVING BUMPER - Outil de déclipsage pare-chocs



076518

NEW



x15
076525

PLASTIC WELDING STATION - Station de soudage des plastiques - Kunststoff-Schweißset



320 W - 230 V, 1-50 Hz
Temperature: 160 < 480°C
▲ 3.4 kg
Length of hose: 1 m
Air flow: 24 l/min

Station seule
- Station only
064072



Ø 5 mm
066694

Ø 8 mm
066700

plastic rods - baguettes plastique 440 mm	PP / EPDM	▲ 4 mm	x 10	066304
		■ 6 mm	x 10	067622
	ABS	▲ 4 mm	x 10	071322
		■ 8 mm	x 10	071339

Station	PP/EPDM			Pressure wheels	Mini milling machine	Scraper
	4mm (x10)	6mm (x10)	8mm (x10)			
064072	✓					
070974		✓				



Scraper - Grattoir
068032

Pressure wheels
- Roulette de
compression
058231

Mini milling machine
- Mini fraiseuse
063228

Tungsten drill
Ø 5 mm
included
063235

WELDING KIT FOR PLASTICS - Kit de soudage des plastiques - Kunststoff-Schweißset



1 600 W - 230V - 50/60 Hz
max. 230 l/min
▲ 1.3 kg / -L- Ø100 x 300mm,
poignée Ø 56mm.

057678

3m

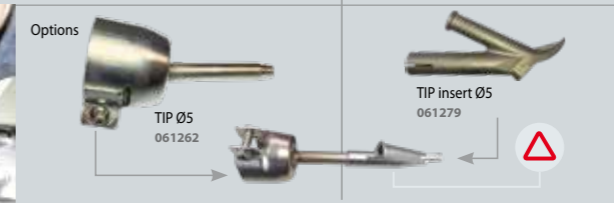
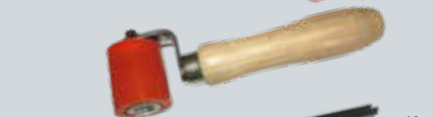
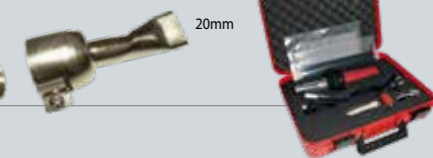

TIP Ø5
061262

TIP insert Ø5
061279



x10
052956

x1
25 x 12.5 cm
052949

BRAZING AUTOMOTIVE PLASTICS REPAIR KIT - Coffret de réparation des plastiques automobiles - Kunststoff Reparatur Set



052932

MADE IN BELGIUM



x10
052956

25 x 12.5 cm
x2
052949

057258

052963

HAND TOOLS - Ausbeulwerkzeug

• FULL PACK = 061637

MADE IN GERMANY

50 mm

15

290 mm

275 mm

50 mm

390 mm

Ø 50 mm

MADE IN HIGH QUALITY GERMANY

053311 053298 061309 053335 053342 053328 053281

+ • MEDIUM PACK 051133

55

450 mm

051430 051416 051454 051447 051409

051423

(9 dents/pouce - 9 teeth/inch) 062351

(15 dents/pouce - 15 teeth/inch) 062368

0.70 kg 051485

0.95 kg 051478

1.33 kg 051461

BURR REMOVER - Outil d'ébavurage - Gratentferner

NEW 079854

x 10

PLANISHING HAMMER BLACKTEC®

077270

Rubberised gripping - Manche en caoutchouc

NEW

MADE IN GERMANY

Corrosion resistant

CONTOUR GAUGE - Jauges de profil - Kontourenlehre

052840 250 mm

057265 500 mm

GAPPING GAUGES - Jauges de positionnement - Spaltmaßlehre

x2 054752

FENDER ROLLER TOOL SET - Outil de remise en forme passage de roue

060791

ALU HAMMERS - Marteaux alu

020986

FORMING TOOLS - Outils de forme - Formgebungswerkzeuge

051195

180 x 70 x 65 mm

280 x 95 mm

280 x 95 mm

75 x 65 mm

BODY LINE TOOL - Traceur de ligne carrosserie - Markierhilfe für Kanten

078758

NEW

170 mm max

Dry-wipe marker - Marqueur effaçable à sec

FIXED HINGE BENDING TOOL - Redresseur de charnière de porte

051102

Door hinge straightener - Redresseur de charnière de porte - Türgelenkausrichter

40 mm max

LIP PLIER - Pince à lèvres - Falzzange gebogen

079649

NEW

45 mm

PLANISHING KIT FOR CAR BODY (SET OF 3 HAMMERS + 4 DOLLYS) - Kit marteaux et tas - Karosseriehammer & Handfaust Kit

057579

40 x 40 mm 70 x 90 mm 1.4 kg 061408

117 x 57 mm 1.2 kg 061415

117 x 57 mm 1.2 kg 061422

SET OF 30 TOOLS FOR SCRAPING/SANDING AND PAINT REMOVAL - Outils de dégarnissage et raclage - Polster & Schaber Kit

057616

HAND CHISEL FOR CAR BODY - Burins - Meißel für Karosserie

26 x 7 mm 057586

26 mm

230 mm

60 x 11 mm 057593

60 mm

245 mm

SET OF 3 CHISELS - Lot de 3 burins de séparation éléments collés - 3 Meißel

076754

NEW

250 mm

300 mm

300 mm

SET OF 4 NYLON CHISELS - Jeu de 4 burins en nylon - 4 Kunststoffmeißel

054745

273 mm

19 mm (x1)

22 mm (x1)

25 mm (x1)

38 mm (x1)

SET OF 3 SCRAPING KNIFES - Couteaux racloirs

061439

15 mm

20 mm

30 mm

POSITIONING CLAMP - Pinces de maintien bord à bord - I-Stoß-Lehre

043190 (x4)

MICRO-GRIP CLAMPS - Pinces micro-grip

061330 (x4)

20 mm max

95 mm

MICRO-WELDING CLAMPS - Micro-bridés de soudage

079373 (x4)

NEW

7 mm max

FLAT NOZE LOCK-GRIP PLIERS - Pinces étau à bec plat

062719

250 mm

100

max 25

75

max 20

200 mm

TEMPORARY-FASTENERS MANUAL MOUNTING - Serre-tôles

(x10) Ø 2,4 mm 069664

(x10) Ø 4,0 mm 069671

(x10) Ø 4,8 mm 069688

(x10) Ø 6,4 mm 069695

AXIAL-GRIP PLIERS - Pinces axiales

050242

Type I Type J Type JJ Type W Type LL Type G

280 mm 061378 x6

80 mm

610 mm 061354 x2

410 mm

460 mm 061361 x4

240 mm

Flat noze - 610 mm 061347 x2

410 mm

LOCK-GRIP PLIERS - Pinces étau mono serrage

Flat noze - 460 mm 050112 x6

240 mm

KIT: 050266 x3

280 mm Flat noze x3

x3

x5

x5

= 16

MINI DISC SANDER - Mini-meuleuse - Druckluftschleifer

051829

Speed adjustment

Ø 75 mm

Speed rpm	Power W	dB	Air consumption l/min	Air pressure bar	cm	kg
18000	200	83	171	6.2	12	0.7

Included (x1) 052468

LONG HANDLED ANGLE GRINDER - Meuleuse d'angle - Druckluft-Winkelschleifer

057753

Ø 100 mm

± 1.6 mm, x5 057883
± 0.8 mm, x5 058217

Speed rpm	Power W	dB	Air consumption l/min	Air pressure bar	cm	kg
14000	84	113	6.2	37	1.7	

058248

MINI-FLEXIDISC LAMELLES ZIRCON Ø 50 mm

K 40 (x10) 058255
K 60 (x10) 058262
K 80 (x10) 058279

x2 Ø
Ø 50 & 75 mm

Speed rpm	Power W	dB	Air consumption l/min	Air pressure bar	cm	kg
15000	84	91	6.2	10	0.6	

MINI ANGLE GRINDER - Mini-meuleuse à renvoi d'angle - Mini-Druckluftwinkelschleifer geräuschgedämpft

051867

Ø 50 mm

90°

Speed rpm	Power W	dB	Air consumption l/min	Air pressure bar	cm	kg
15000	200	86	85	6.2	18	0.75

(x1) 052772

AIR BELT SANDER - Ponceuse à bande à tête orientable - Druckluft Bandschleifer

060906

520 mm

20 mm

360°

Grain 60 (x5) 060913
Grain 80 (x5) 060920
Grain 100 (x5) 060937
Grain 36 céramique (x5) 062535

Speed rpm	Air consumption l/min	Air pressure bar	cm	kg
16000	171	6.3	34	1.2

SAW FOR STRAIGHT CUT AND FILE - Scie coupe tôle droite et lime - Druckluftsäge und Feile

051805

(x5) 052789

included 058750

Speed rpm	Power W	dB	Air consumption l/min	Air pressure bar	cm	kg
5000	—	85	255	6.2	10	0.8

AIR BELT SANDER - Ponceuse à bande à tête orientable - Druckluft Bandschleifer

052819

360°

330 mm

10 mm

Grain 80 (x10) 052833
Grain 36 céramique (x20) 062528

Speed rpm	Air consumption l/min	Air pressure bar	cm	kg
16000	171	6.3	26	0.9

MINI ANGLE MILLING MACHINE - Mini-fraiseuse à renvoi d'angle - Mini-Winkelschleifer

051836

90°

Speed rpm	Power W	dB	Air consumption l/min	Air pressure bar	cm	kg
18000	500	81	85	6.2	18	0.7

AUTOMATIC MANDREL DRILL - Perceuse mandrin automatique - Druckluftbohrmaschine m. Schnellspannfutter

051799

Ø 13

Speed rpm	Power W	dB	Air consumption l/min	Air pressure bar	cm	kg
800	300	92	170	6.2	18	0.9

PNEUMATIC SURFACE REMOVER KIT - Coffret décapeuse pneumatique - Druckluftentroster-Box inkl. Zubehör

051775

Roue gomme 115 x 14 mm 051874
Roue à découper 115 x 14 mm 051843
Adaptateur pour brosse 051768

Brosse souple Brins droits 0.5 mm 103 x 23 mm 052598
Brosse dure Brins incurvés 0.7 mm 103 x 23 mm 051812
Brosse souple Brins incurvés 0.5 mm 103 x 23 mm 051850

Speed rpm	Power W	dB	Air consumption l/min	Air pressure bar	cm	kg
4000	500	86	102	6.2	280	1.2

PNEUMATIC FLANGE / PUNCHING TOOL - Pince à soyer et à trouser, pneumatique - Pneumatische Loch- und Absattzange

079892 Ø 8 mm
0.8 > 1,2 mm

052543 Ø 5 mm
0.8 > 1,2 mm

2 in 1

0.8 > 1,2 mm

MINI MILLING MACHINE - Mini Fraiseuse - Mini-Schleifer

063228

Option Tungsten drill Ø 6 mm 054172

PUNCHING TOOL FOR OVAL HOLES - Outil de poinçonnage oblongs - Langlochkarosserieblechzange

2.2 kg

6 mm 20 mm 052437
8 mm 20 mm 067264

BODY ZIPPER - Sertisseuse pneumatique - Pneumatic Crimper - Druckluftkantenformer

056930

MADE IN HIGH QUALITY POLAND

1) MINI
2) initial W
3) final M x < 2.4mm
4) final D x > 2.4mm

total thickness x=2a+b

Air pressure bar	cm	kg
5	28	2.1

LASER CORD METAL SHEET CUTTER (NIBBLER) - Dépointeuse pour cordon laser ACIER - Trennwerkzeug für Lasernähte

054165

Ø 6 mm

STEEL Included 054172

SPOT REMOVER - Dépointeuse - Druckluft-Schweißpunktbohrer

SPOT DRILL 050464

360°

Ø 8

Included: Tungsten Carbide Ø 8 for BORON/UHSS (x1)

HIGH QUALITY

Spot remover drill - Forets de dépointage - Schweißpunktfräse Tungsten Carbide for BORON/UHSS

Speed rpm	Power W	dB	Air consumption l/min	Air pressure bar	cm	kg
800	400	85	140	6.5	35	2.3

PACK SPOT DRILL + 140 mm 061460

3-edge Ø 8 mm 053069
140 mm 061453



FILM COATING THICKNESS GAUGE
- Détecteur épaisseur de peinture

059856

Measurement range : 0 – 1.80mm
Resolution : 0.01mm / 1mm
Measurement error : +/- 0.03 mm
Power Supply : 2x 1.5V AAA batteries (included)
Overall dimensions : 62 x 30.5 x 105 mm

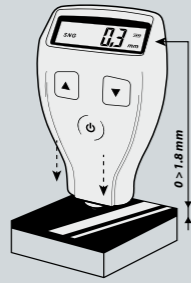

ELECTRIC SANDER & POLISHER
- Ponçeuse /polisseuse électrique - Elektro-Polier-Schleifer

057999

Orbital 5.0 mm
↓ 27 x 15 x 10 cm / 1.5 kg
⊗ 37 x 18 x 12 cm / 1.9 kg

Speed : 4000, 7000, 9000 10000 rpm
AC-in 220V - 230V / 50 - 60Hz

Light weight
& Compact

Speed control

((No vibration))

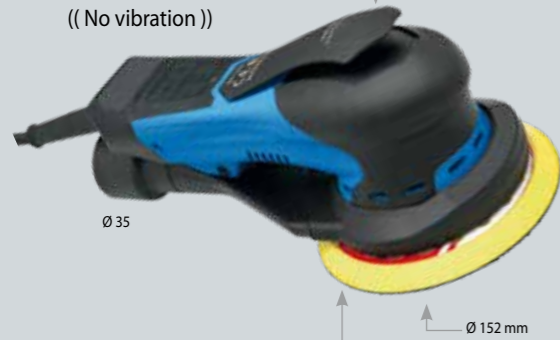

Ø 35

Ø 152 mm

PNEUMATIC ALUMINIUM DUST ATEX VACUUM CLEANER
- Aspirateur pneumatique pour poussières alu (atex)

058866

Dust container capacity : 25 l
Working compressed air pressure : 7 bar
Compressed air consumption at 6 bar : 800 l/min
Suction connection diameter size : 50 mm
Max suction capacity : 150 m³/h
Max vacuum level : 2000 mm H₂O
Recommended compressor power : 7.5 HP

↓ 74 x 45 x 45 cm / 22.5
⊗ 78 x 58 x 97 cm / 25 kg



058293

Power supply : 230V / 50Hz
Power : 1400W (max 2000W)
Max. vacuum : 170 mbar
Air flow : 2700 l/mn
Drum capacity : 30 L
Drum material : stainless steel

↓ 33 x 33 x 63 cm / 4.9 kg
⊗ 38 x 38 x 67 cm / 7.8 kg

Manual or automatic



4m
Input Ø 32 mm
Mains cable length 4.5m



included
Filtre - Filter
075405



included
Sac à poussières - Filter bag
Capacity 5 kg
x5
058880



5 m
Output Ø 29 mm
Input Ø 35 mm

GYS DUST EXTRACTOR - Pneumatic dust vacuum cleaner for sander

INNOVATIVE SUCTION SYSTEM

Depression **1150 mm H₂O**
Air flow **600 l/min**
Air consumption **340 l/min**



Adjustable sander pressure - Pression ponçeuse ajustable
5 bar max

↓ 49 x 48 x 88 cm / 21.5 kg
⊗ 81 x 40 x 49 cm / 24.1 kg



ATEX norm
Group II - Category 3

EN 60335-2-69: 2012

- ✓ **ROBUST**
- ✓ **QUICK & SAFE**
- ✓ **LOW AIR CONSUMPTION**
(5 bar)
- ✓ **NO ELECTRIC MOTOR**
- ✓ **ENERGY SAVING**

Sanding discs box*
- Rangement pour disques de ponçage*
* discs box not included - disques de ponçage non inclus

Grande maniabilité et stabilité
- High maneuverability and stability

EASY ACCESS

Maintenance free
- Aucune maintenance

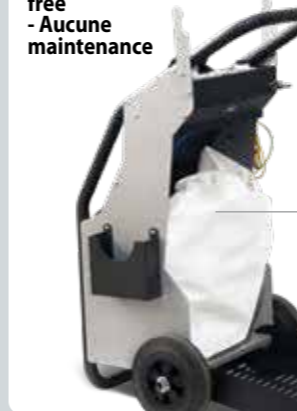

Consumables

Sac à poussières - Filter bag
Capacity 5 kg
Included x1
x5
058880



Ponçeuse non fournie
- Sander not included

5 m
Ø 29 mm

Option :
10m
Ø 29 mm
076013



Included
Earth clamp
safety



Pneumatic Sander
- Ponçeuse pneumatique
MIRKA PROS 650CV
Ø 150 mm
071346

2 MODELS

GYS DUST EXTRACTOR

MANUAL

Manual start
- Démarrage manuel

071353



GYS DUST SELF EXTRACTOR

AUTOMATIC

Automatic start
- Démarrage automatique

077058



HAND LAMPS - Lampes baladeuses - Handleuchte

Lampe BALADEUSE TRIPODE 250 L
100-250 lumens (x3)

3 x 1 W COB LED
3 x 3.6 V - 300 mAh
AAA rechargeable, Ni-MH
USB charging (6h)
operating time
High position: 1 h
Low position: 3 h
Flashing: 5 h

↓ 10 x 10 x 26 cm / 0.6 kg
⊗ 21 x 11 x 27 cm / 1 kg



Lampe BALADEUSE 400 L
400 lumens

COB LED
Li-ion
Charging time: 8h
operating time
High position: 2.5 h
Low position: 5 h
Top light (1 W): 6 h

↓ 7 x 4 x 23 cm / 0.3 kg
⊗ 14 x 7 x 24 cm / 0.5 kg



Lampe BALADEUSE PRO 600 L
250-600 lumens

COB LED, 80 CRI
3.7 V - 2200 mAh Li-ion
micro USB charging (3.5 h)
operating time
High position: 1.5 h,
Mid position: 4.5 h,
Top light (100 lumens): 10 h

IP 54
↓ 3 x 6 x 19 cm / 0.3 kg
⊗ 9 x 13 x 24 cm / 0.6 kg



INSPECTION LAMPS

- Lampes d'inspection - Inspektionslampen

Lampe INSPECTION FRONTALE 280 L
100-280 lumens

3 W COB LED, 80 CRI+, 6500 K
3.7 V - 1500 mAh Li-po
micro USB charging
mains charger not incl.
operating time
High position: 2 h
Low position: 6 h
IP 65
↓ 8 x 5 x 4 cm / 0.1 kg
⊗ 5 x 11 x 18 cm / 0.2 kg

060845



Lampe AMBIANCE 360° PORTABLE 1000 L
60-1000 lumens

>80 CRI SMD LED
6500 K
3.7 V - 5200 mAh Li-ion
USB charging (4.5h)
USB power supply
operating time 2 > 27 h

IP 54
↓ 26 x 7 x 7 cm / 0.5 kg
⊗ 8 x 8 x 35 cm / 0.7 kg

059764



Lampe INSPECTION MINI 200 L
120-200 lumens

COB LED, 80 CRI, 6500 K
3.7 V - 700 mAh Li-ion
micro USB charging (2.5 h)
mains charger not included
operating time
High position: 1.5 h
Low position: 4 h
Top light: 3.5 h
IP 20
↓ 18 x 3 x 3 cm / 0.1 kg
⊗ 18 x 5 x 3 cm / 0.2 kg

060852



Lampe INSPECTION MINI 350 L
0-350 lumens

COB LED
3.7 V - 1100 mAh Li-ion
USB charging (3 h)
operating time
3 > 6.5 h

IP 20
075894

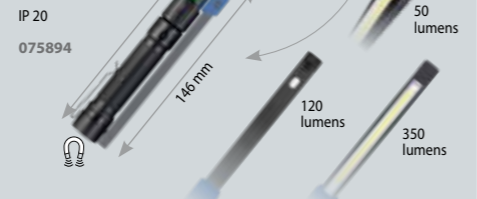

Lampe INSPECTION PRO 600 L
0-600 lumens

COB LED
6500 K
3.7 V - 2600 mAh Li-ion
USB charging (4 h)
operating time
1.5 > 15 h

057760
058309

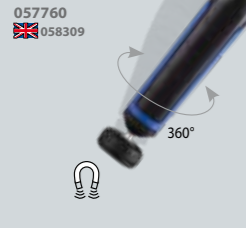

Lampe INSPECTION PRO 800 L
120-800 lumens

COB LED
3.7 V - 2600 mAh Li-ion
USB charging (4 h)
operating time
2.5 > 9 h

IP 54
075900

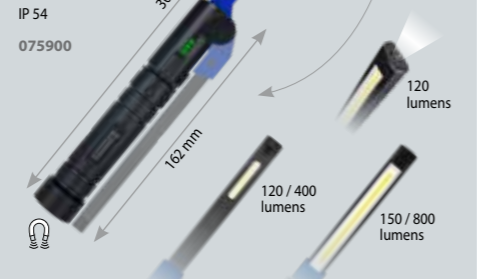

UNDER BONNET LAMPS - Lampes sous capot - Leuchte für Motorhaube

Lampe SOUS CAPOT 600 L
500-1000 lumens

120 COB LED
3.7 V - 4000 mAh Li-ion
charging time: 10/12 h

operating time
High position: 4 h
Low position: 8 h

059962



Lampe SOUS CAPOT 800 L
250-800 lumens

120 COB LED
3.7 V - 4000 mAh Li-ion
charging time: 10/12 h

operating time
High position: 3 h
Low position: 6 h

058002
058316



LED WORKLIGHTS WITH TRIPOD - Projecteurs led sur trépied - LED-Arbeitsleuchte mit Standfuß

Lampe sur TRÉPIED 1800 L
1800 lumens

3 x 55 COB LED
total 165 LED
1.8 m power cord
059146

⊗ 95 x 15 x 14 cm / 3.2 kg



Lampe sur TRÉPIED 3000 L
3000 lumens

35 W COB LED
2 m power cord
IP 44
059979

⊗ 100 x 20 x 9 cm / 3.6 kg
⊗ 103 x 22 x 10 cm / 4.1 kg



Lampe sur TRÉPIED 4000 L
4000 lumens

3 x 20 COB LED,
total 60 LED
3 m power cord
059986

⊗ 21 x 15 x 114 cm / 5.7 kg
⊗ 22 x 116 x 117 cm / 6.4 kg



DETAILING & COLOUR MATCH - Contrôle des couleurs - Fabnpassung & Aufbereitung

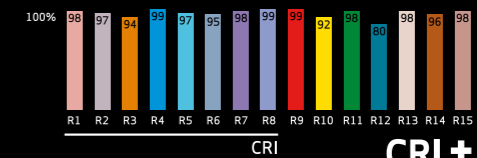

4500 K

400 lumens

SUNCOLOR 1
COB LED, CRI > 95, 1100 lux
3.7 V - 2600 mAh Li-ion
USB charging
operating time: 3 h
↓ 6 x 3 x 19 cm / 0.6 kg
⊗ 22 x 14 x 10 cm / 0.7 kg
IP 65

058477



3 COLORS

2700 - 4500 - 6500 K

350-420-450 lumens

SUNCOLOR 3
COB LED, 96 CRI+
3.7 V - 2600 mAh Li-ion
micro USB charging (4 h)
operating time: 2.5/4 h
IP 65
↓ 4 x 6 x 9 cm / 0.3 kg
⊗ 9 x 13 x 24 cm / 0.6 kg

060838



5 COLORS

2700 - 3500 - 4500 - 5500 - 6500 K

500-1000-2000 lumens

SUNCOLOR 5
COB LED, 96 CRI+
11.1 V - 4400 mAh Li-ion
charger 110/240 V, 5 m cable, 15 V, 1.5 A
charging time: 3.5 h
operating time
High position: 2 h, Mid: 4 h, Low: 8 h
IP 65
↓ 7 x 23 x 20 cm / 1.2 kg
⊗ 9 x 25 x 24 cm / 1.9 kg

060876

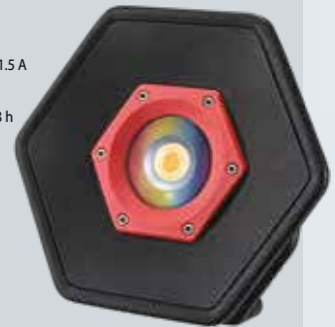

5 COLORS

2500-3500-4500-5500-6500 K

250-500 lumens

SUNMATCH 3
COB LED, 96 CRI+, 700-1400 lux
3.7 V - 2600 mAh Li-ion, USB charging
operating time:
High position: 2 h, Low position: 4 h
IP 65
↓ 4 x 6 x 19 cm / 0.3 kg
⊗ 8 x 9 x 21 cm / 0.5 kg

061651



UV CURING - SÉCHAGE UV

UV LED λ 395-400 nm

Irradiance 6-15 mW/cm²

NOVA-UV S
3.7 V - 5400 mAh Li-ion
COB LED, 1 m cable, 5 V, 2 A
charging time: 3.5 h
curing area: Ø 20 cm
operating time 1.5 h
IP 67
↓ 7 x 17 x 16 cm / 0.9 kg
⊗ 7 x 17 x 18 cm / 1 kg

061620



FRAMES SUPPORT - Tréteaux - Klappböcke

040601
↓ 105 x 33 x 9 cm / 6.3 kg
⊗ 107 x 35 x 10 cm / 6.7 kg

Ø28 mm

Bent feet for grating
- 4 pieds courbes
- Idéal sur caillbotis
- Abgewinkelte Standfüße
- Sicherer Stand auf Gittern u.ä.

040250
↓ 100 x 105 cm - 7.1 kg
⊗ 104 x 10 x 32 cm / 7.5 kg

Ø32 mm

040311
↓ 106 x 31 x 6 cm / 6.6 kg
⊗ 106 x 31 x 11 cm / 9.7 kg

Ø32 mm

Suction pad for glazing
- 4 ventouses
- Dépose vitrages
- Gummiteiler zur Fixierung von Glasscheiben

040304
↓ 105 x 109 cm / 7.2 kg
⊗ 107 x 32 x 10 cm / 7.8 kg

Ø32 mm

Light and easy to handle
- Idéal for horizontal works
- Léger et très maniable
- Spécial travaux à l'horizontal
- Speziell geeignet für Arbeiten in horizontaler Position

Adjustable catenary
- Chainette réglable

Protecting foam
- Mousse de protection

Non-slip base
- Antidérapants

MADE IN HIGH QUALITY POLAND

20 x 20 mm 16.5 kg

15 > 125 cm 88 > 128 cm 3 mm 87 cm

070677

PREMIUM MASKING MACHINE
- Chariot de luxe marouflage
- Abdeckpapier-Ständer

057333
150 x 133 x 62 cm
31 kg
⊗ 152 x 30 x 18 cm / 31.5 kg

056954
150 x 62 x 110 cm / 11 kg
⊗ 154 x 30 x 19 cm / 12 kg

MADE IN HIGH QUALITY POLAND

x 5 (not included)

Paper roll
- Rouleaux de papier
- Papierständer
30 > 120 cm

OPTION

Ø 40 mm
x 6
058897

x 3 (not included)

Paper roll
- Rouleaux de papier
- Papierständer
30, 60, 90 cm

STORAGE TROLLEY - Chariot de stockage - Lagerrollwagen

040243
71 x 90 x 197 cm
41 kg
⊗ x2: 90 x 6 x 147 cm
+ 97 x 74 x 24 cm

FLAP LOCK - Tiges de blocage

056732

30 > 115 cm

ROTARY ELEMENT SUPPORT - Support pare-chocs - Lackierständer für Stoßstange, einstellbar

052376
↓ 50 x 70 x 10 cm / 7.3 kg
⊗ 60 x 77 x 12 cm / 8.3 kg

059825
106 x 104 x 215 cm - 32.5 kg
112 x 31.5 x 21.5 cm
+ 12 x 9.5 x 194.5 cm

059832
↓ 50 x 150 cm - 11.3 kg
⊗ 155 x 18 x 12 cm / 13.8 kg

Adapté aux coques de rétroviseurs
- Adapted to wing mirror covers
- Geeignet für Außenspiegel

UNIVERSAL SUPPORT - Chariot pour éléments de carrosserie - Universelle Ständer

066281
⊗ 120 x 80 x 13 cm / 24 kg

NEW

max 80 kg Ø 4.5 cm

80 cm 70-100 cm 115 cm Ø 12.5 cm

MADE IN HIGH QUALITY POLAND

ROUND STOOL WITH TOOL STORAGE - Tabouret - Werkstatt-Rollhocker

057555
38 x 38 x 44 cm - 5.2 kg
⊗ 41 x 19 x 41 cm / 5.6 kg

max: 50 cm
min: 38 cm

6 cm

MECHANICS CREEPER WITH TILTING HEADREST - Chariot de visite - Werkstatt-Rollliege

057548
102 x 43 x 11 cm / 5.3 kg
⊗ 104 x 45 x 13 cm / 6 kg

ROUND STOOL WITH STORAGE - Tabouret d'atelier 3 tiroirs

079878
47 x 35 x 43 cm
38.5 x 37 x 38.5 cm - 13 kg

NEW

ROTARY ELEMENT SUPPORT - Support élément rotatif - Lackierständer für Stoßstange, einstellbar

052611
200 x 101 cm - 19 kg
⊗ 112 x 35 x 13 cm / 23 kg
Made in China

PRO
056725
200 x 105 x 81 cm - 21.5 kg
⊗ 120 x 26 x 18 cm / 22 kg

1.5 mm 360° 2 mm

Verrouillage de l'axe - Locking of the axis
- Verriegelung der Achse

MADE IN HIGH QUALITY POLAND

EXTENDABLE SUPPORT - Chariot extensible pour éléments de carrosserie - Ausziehbarer Wagen

061507
29.4 kg
⊗ 112 x 42 x 14 cm / 30 kg

max 150 kg 100 cm

135 - 210 cm

MADE IN HIGH QUALITY POLAND

2 IN 1 MECHANICS CREEPER - Chariot de visite 3 en 1 - Werkstatt-Rollliege

079861
102 x 40 x 14 cm
40 x 13 x 63 cm - 7.6 kg

NEW

1 2

FOLDING STEP STOOL - Marche pied (Aluminium) - Arbeitspodest klappbar

057562
7.9 kg
⊗ 102 x 39 x 19 cm / 8.5 kg

960 mm 475 mm 385 mm

150 kg ALU

NEW

080041
7.3 kg
⊗ 100 x 39.5 x 19 cm / 8.1 kg

850 mm 490 mm 1180 mm

150 kg ALU

NEW

058552

↓ 113 x 41 x 16 cm / 16 kg
⊗ 117 x 42 x 17 cm / 17 kg

1090 > 1750 mm 520 > 900 mm

150 kg ALU

Complete carbody workstation
080119

included



Workstation only
076143

MOBILE WORKSTATION
- Table de travail mobile



WORKSTATION 3 SHELVES
- Servante 3 plateaux



HEAT COVER - Couverture anti-chaaleur - Hitzschutzdecke - Manta anti-calor - Protecção anti-aquecimento



SET OF 2 MAGNETS

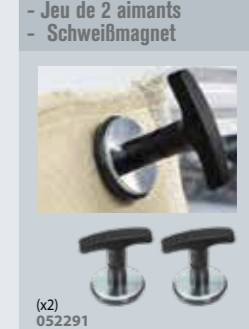

MAGNETIC COVER - Couverture magnétique - Magnetschutzdecke



RIDEAU DE SOUDAGE - Welding curtain and frame - Schweißerschutzwand



RESPIRATORY MASKS - Masques respiratoires - Atemschutzmaske - Máscaras respiratorias



PROTECTION GOGGLES
- Lunettes de protection - Schutzbrillen



GLOVES - Gants - Handschuhe - Guantes



MULTI-USE LEATHER APRON
- Tablier cuir multi-usage
- Delantal de cuero multi-uso
- Mehrzweck-Lederschürze



EQUIPMENT FOR OPERATIONS ON ELECTRIC AND HYBRID VEHICLES - Équipements pour opérations sur véhicules électriques & hybrides - Ausrüstung für den Betrieb von Elektro- und Hybridfahrzeugen

FACE SHIELD WITH HEADBAND
- ÉCRAN FACIAL AVEC SERRE-TÊTE
068018



INSULATING GLOVES (T10)
- GANTS ISOLANTS (T10)
068025



25 pieces insulated tools 1000V - Coffret de 25 outils isolés 1000V
- Box mit 25 isolierten Werkzeugen 1000V
066489

7/8/10/12/14/15/17/19/22 mm sockets - Douilles 7/8/10/12/14/15/17/19/22 mm	x 9
175 mm universal pliers in chrome vanadium - Pince universelle de 175 mm en chrome vanadium	x 1
Cutting pliers 150 mm in chrome vanadium - Pince coupante 150 mm en chrome vanadium	x 1
3/8" ratchet - Cluqjet en 3/8"	x 1
Extension 100 mm - Rallonge 100 mm	x 1
T-handle - Poignée en T	x 1
Open ended wrenches 7/8/10/12/14/17 mm - Clés plates à fourches 7/8/10/12/14/17 mm	x 6
Cable knife - Couteau pour câble	x 1
Phillips PhH1x100/PhH2x100 mm screwdriver - Tournevis Phillips PhH1x100/PhH2x100 mm	x 2
Flat screwdriver 5.5x125 / 4x100 mm - Tournevis plats 5.5x125/4x100 mm	x 2



Kit for marking the area of intervention
- Kit pour le balisage de la zone d'intervention
- Kennzeichnungsset für Hochvolt-Bereiche
064409

Red and white warning pole - Balise de signalisation rouge et blanche	x 4
Red and white bounding line - Chaîne de délimitation rouge et blanche	x 1
Sign board "Danger, working area EHV" - Pancarte de signalisation "Danger, zone de travail VEH"	x 2



TROUSER - Pantalon - Hose



EN ISO 11611 Class 2-A1 & A2	98% cotton, 2% antistatic
EN ISO 11612 A1+A2-B1-C1-E3-F1	S (40/42) 046368
EN 1149-5	M (44/46) 046375
IEC 61482-2 Class 1-4kA	L (48/50) 046382
EN 14404 +A1 Type 2	XL (52/54) 046399
	XXL (56/58) 046412

JACKET - Veste - Jacke



IEC 61482-2 Class 1-4kA	98% cotton, 2% antistatic
EN ISO 11612 A1+A2-B1-C1-E3-F1	S (40/42) 046313
EN 14404 +A1 Type 2	M (44/46) 046320
EN ISO 11611 Class 2-A1 & A2	L (48/50) 046337
EN 1149-5	XL (52/54) 046344
	XXL (56/58) 046351



★★★★★ **THEY TRUST US** ★★★★★

ILS NOUS FONT CONFIANCE

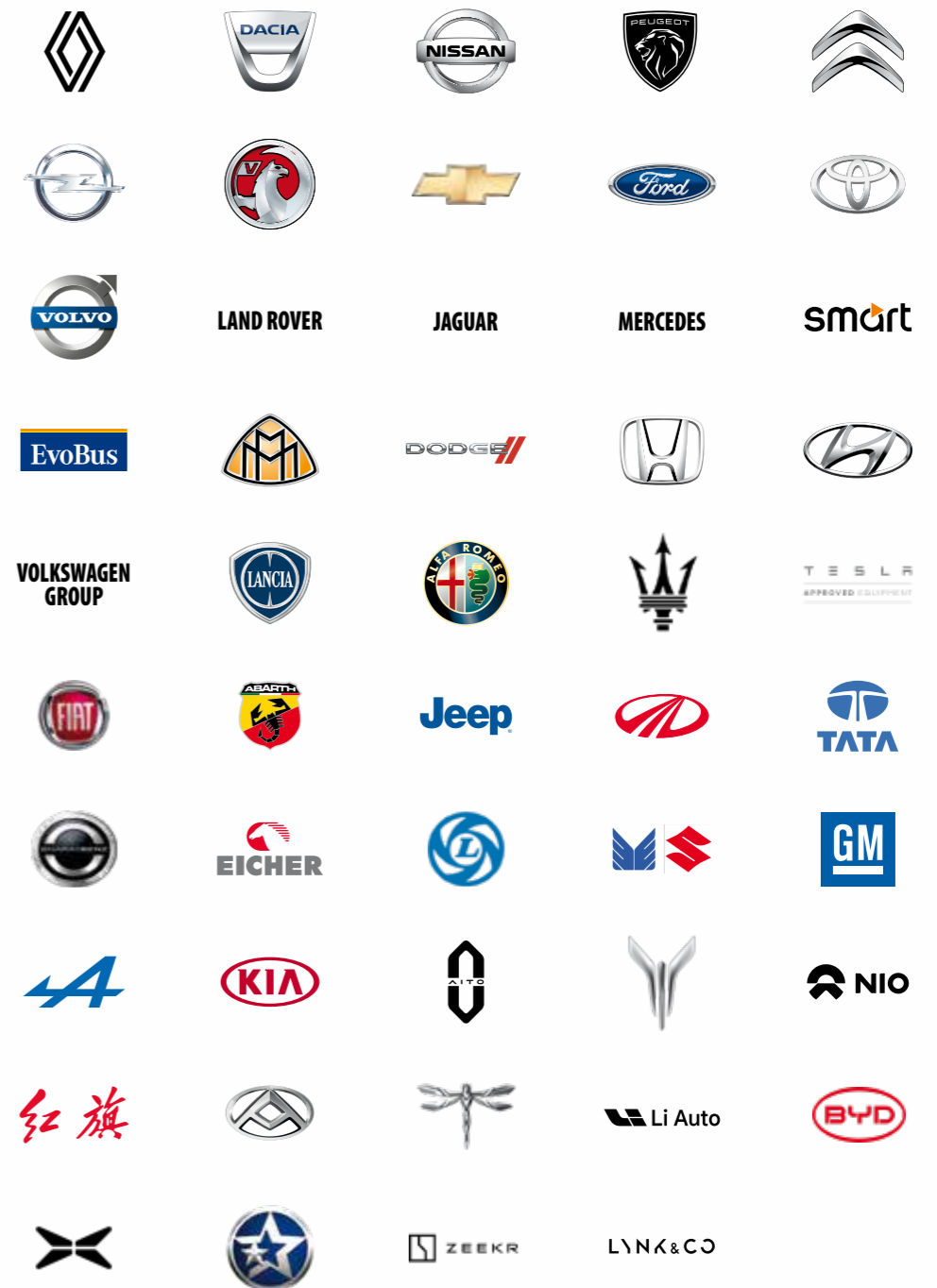



INVEST IN THE FUTURE



French manufacturer
since 1964

2
0
2
3
B

Car Body Welding Systems

Catalogue Carrosserie
Catalogo Carrozzeria
Karosserie-Schweißtechnik Katalog
Catálogo de Soldadura para Carrocería



LinkedIn
Youtube
WeChat
Facebook
Instagram

www.gys.fr



GYS FRANCE

HEADQUARTERS

1 rue de la Croix des Landes
CS 54159
53941 Saint-Berthevin - Cedex
Laval - France
Tel +33 2 43 01 23 60
E-mail service.client@gys.fr



ZI, 134 bd des Loges
53941 Saint-Berthevin
Laval - France

LOGISTIC CENTER

2 Rue Jean Dausset
53810 Changé - France
Tel +33 2 43 01 54 33



GYS GERMANY

Professor-Wieler
Straße 11
52070 Aachen
Deutschland

Tel +49 241/189-23-710
Fax +49 241/189-23-719
E-mail aachen@gys.fr



GYS UK

Unit 3 - Great Central Way
Rugby - Warwickshire
CV21 3XH
United Kingdom

Tel +44 1926 338 609
Fax +44 1926 429 764
E-mail uk@gys.fr



GYS ITALIA

Vega - Parco Scientifico
Tecnologico di Venezia
Via Delle Industrie, 25/4
30175 Marghera - VE
Italia

Tel +39 041 53 21 565
E-mail italia@gys.fr



GYS IBÉRICA

Avenida Pirineos 31
Nave 9
San Sebastian de los Reyes
28703 Madrid
España

Tel +34 917 409 790
E-mail iberica@gys.fr



GYS CHINA

Lot N°15
6666 bd Songze
201706 Qingpu
Shanghai
China

Tel +86 6221 4461
Fax +86 5226 0067
www.gys-china.com.cn
E-mail
contact@gys-china.com.cn

MARKETING

Podium de
présentation
- Display
stand
- Podest

PODIUM 1
A : 45 cm
B : 50 cm
C : 50 cm
063204

PODIUM 2
A : 80 cm
B : 50 cm
C : 50 cm
063211

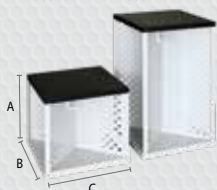

Oriflamme
- Flag
3 x 0,50 m
098015



Barnum 3 x 3 m
098022

Open barnum
2 x 2 m
098039



Linéaire de vente
avec 2 étagères
- Retail display
space
with 2 shelves
- Lochwandregal
mit 2 Böden
(machines not
included)
060784

Distributed by

